



---

# ARRIFLEX 16SR 3

## Instruction Manual

As of: December 1992

ALL ARTWORK, PICTURES AND TEXTS ARE COVERED BY OUR COPY-RIGHT.

THEY MUST NOT BE COPIED FOR REPRODUCTION (E.G. ON CD-ROM DISKS OR INTERNET-SITES) OR USED IN THEIR ENTIRE FORM OR IN EXCERPTS WITHOUT OUR PREVIOUS WRITTEN AGREEMENT.

IF YOU ARE DOWNLOADING PDF-FILES FROM OUR INTERNET HOME-PAGE FOR YOUR PERSONAL USE, MAKE SURE TO CHECK FOR UPDATED VERSIONS.

WE CANNOT TAKE ANY LIABILITY WHATSOEVER FOR DOWNLOADED FILES, AS TECHNICAL DATA ARE SUBJECT TO CHANGE WITHOUT NOTICE.

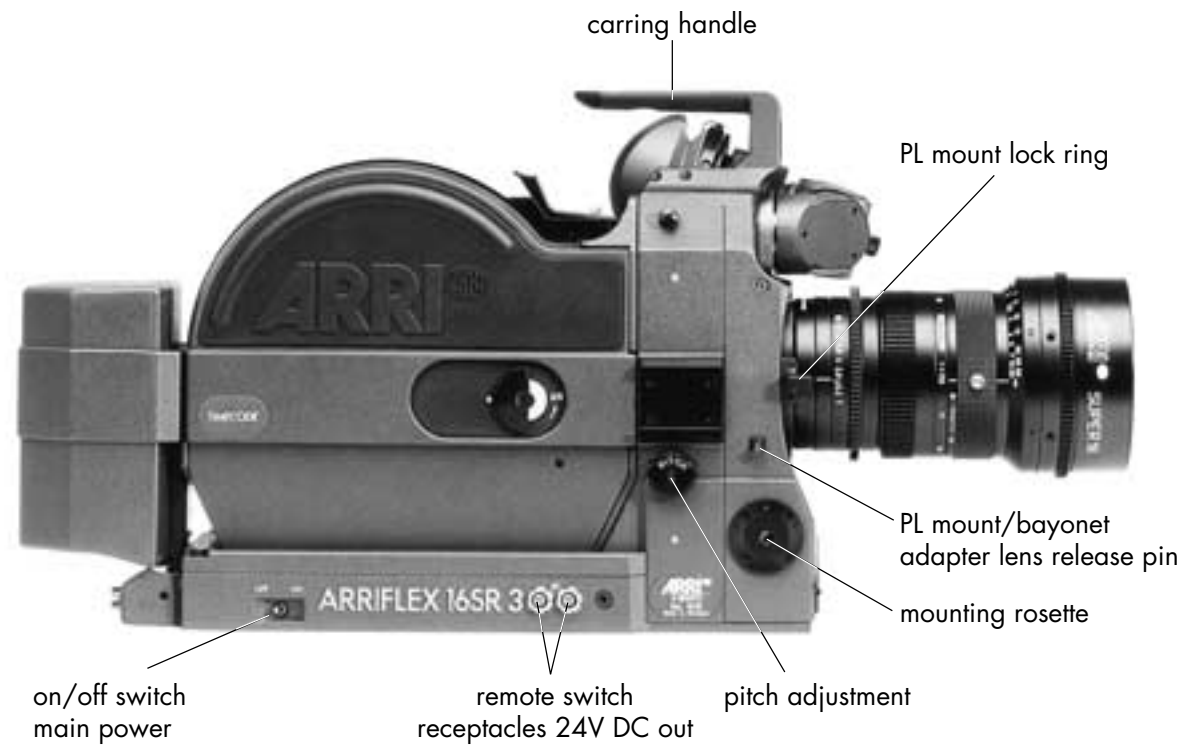
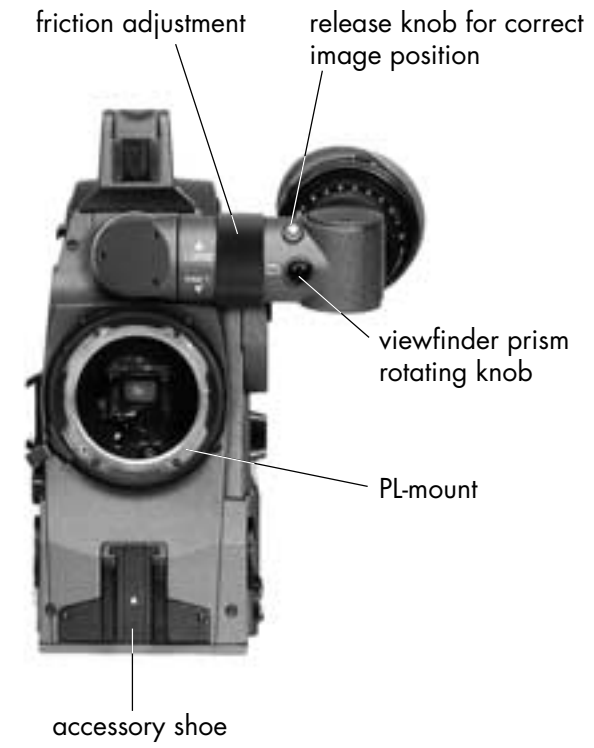
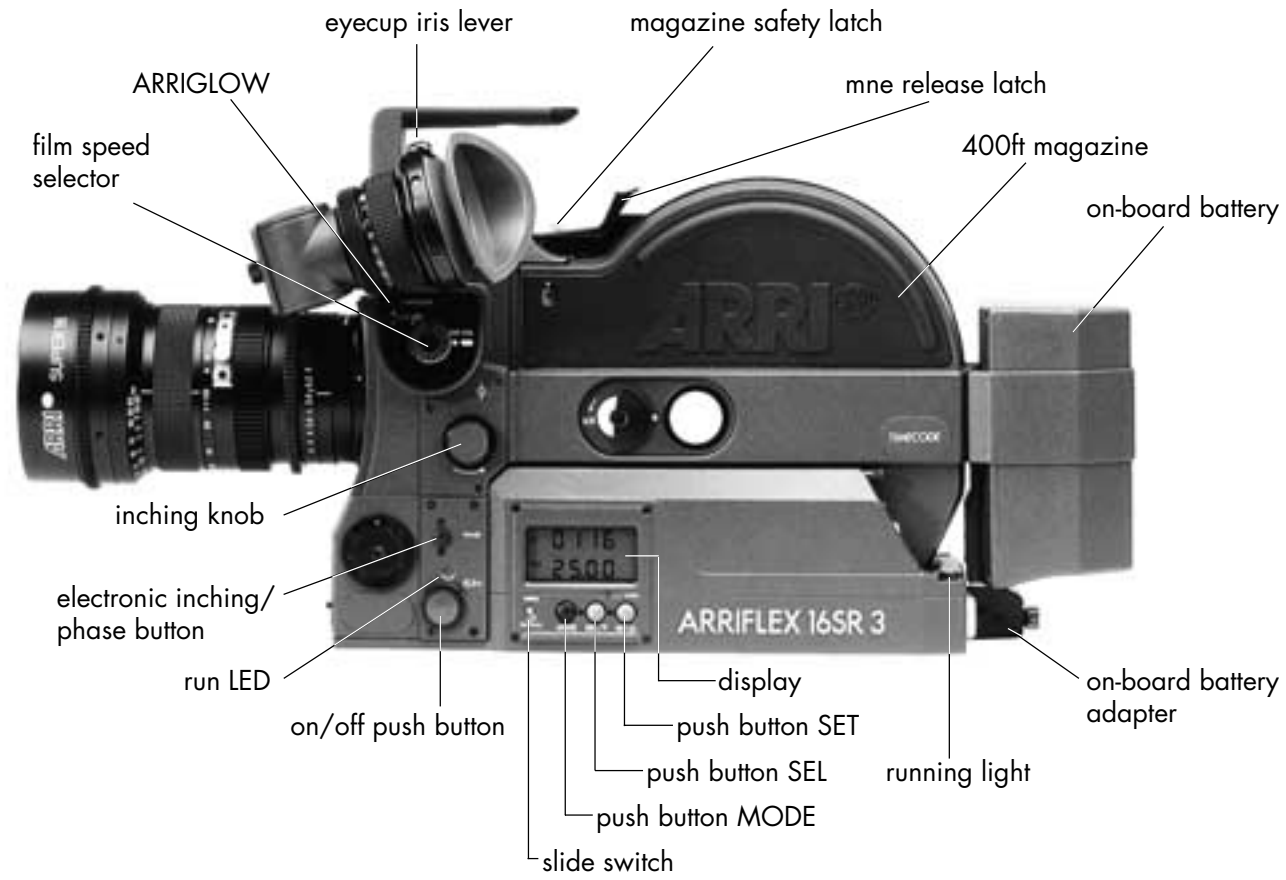

## Safety Specifications

- Warning Notes:



Operational error or camera error possible!

- In order to ensure optimal performance, it is essential that you acquaint yourself with this instruction manual and that you follow the operating instructions described herein.
- Assembly and initial operation should only be carried out by qualified personnel already familiar with the equipment and the assembly procedures!
- Use only original ARRI accessories and replacement parts!
- Clean optic surfaces only with an optic brush or a clean optic cloth! In cases of solid dirt moisten an optic cloth with pure alcohol.
- Do not use solvents in cleaning the film track!
- When adjusting the mirror shutter remove the on-board battery or the supply cable!

- Do not use HS magazines (High Speed) on the standard camera, nor standard magazines on the HS camera!
- Never blow air into the lens opening! If the fiber optic screen is removed the indicator on the light meter can be damaged.
- Do not unscrew any screws which are painted over!
- When using polarizing filters, use only circular polarizing filters as the light meter otherwise will give incorrect readings.

## Product Specifications

In the case of enquiries or when ordering parts please advise type designation and camera number.

# Contents

Safety Specifications .....	1	Cleaning the Magazines .....	18
Product Specifications .....	1	Loading the Magazine .....	19
<b>1. The ARRIFLEX 16SR 3 -</b>		Unloading the magazine .....	24
<b>System-Camera .....</b>	<b>5</b>	<b>5. Camera Body .....</b>	<b>25</b>
<b>2. Installation .....</b>	<b>7</b>	Movement .....	25
Packing and transport .....	7	Mirror shutter .....	26
Tripod heads .....	7	Fibre optic viewing screens .....	29
Bridge plate BP-6 .....	7	Attaching the magazine onto the camera .....	30
Bridge plate BP-7 with 15 mm support rods .....	9	Removing the magazine .....	31
Shoulder set S-3 .....	11	<b>6. Optics .....</b>	<b>32</b>
Camera handgrip .....	11	Lenses .....	32
<b>3. Power Supply .....</b>	<b>13</b>	54mm PL-mount .....	34
On-board battery NC 24/1,2 .....	14	41 mm ARRI bayonet .....	35
Battery NC 24/7 R .....	14	Lens support .....	36
Charger NCL 24 R .....	14	Viewfinder .....	38
Double charger NCL 24/1,2 .....	14	Eyepiece .....	39
Mains unit NG 12/24 R .....	14	Eyecup .....	39
DC/DC converter 24V/12V-22W .....	15	<b>7. Optical Accessories .....</b>	<b>41</b>
<b>4. Magazines .....</b>	<b>16</b>	Light-weight support LWS-2 .....	41
Loop protector .....	16	Universal follow focus device FF-3 .....	43
Magazine door .....	17	Light-weight dollow focus device .....	44
Film core, core holder and clamp core .....	18	Lens-Control-System LCS .....	44
		4"x4" production matte box MB-16 .....	45
		4"x4" matte box MB-17 .....	45
		Light-weight matte boxes LMB-2 and LMB-3 .....	45

Finder extension FE-2 .....	46	<b>12. Time Code</b> .....	80
Levelling rod for finder extension EL-3 .....	47	TC-Indication on the display .....	80
Heated eyecup HE-3 .....	48	TC-Input .....	82
<b>8. Conversion from Normal 16</b>		TC-Output .....	82
<b>to Super 16</b> .....	49	Time code and ESU-1 .....	83
Bridge plates BP-6 and BP-7 .....	53	Using time code .....	83
Lightweight support .....	54	Indicating time code or user bits .....	84
Video optic .....	54	TC buffer .....	86
<b>9. Display and Operating Elements</b> .....	55	Testing the TC recording .....	86
Camera display .....	55	<b>13. Maintenance</b> .....	87
Setting the speed .....	56	Replacing the magazine drive gear .....	87
Film counter .....	58	Cleaning the magazine throat assembly .....	87
Summary of modes .....	58	Flange focal distance .....	89
Exposure control and ARRIGLOW .....	66	Setting friction on the viewfinder .....	92
Checking the mirror shutter setting .....	68	Changing the electronic housing .....	94
Synchronizing on the video monitor .....	68	<b>Appendix</b>	
<b>10. Accessories</b> .....	69	Camera-Checks .....	96
Camera Control Unit CCU-1 .....	69	Technical Data .....	98
External Synchronization Unit ESU-1 .....	74	Order Numbers .....	100
Remote ON/OFF switches RS-3 and RS-4 .....	74	<b>Index</b> .....	102
<b>11. Video-Assist-System</b> .....	75		
Mounting the Video-Assist-System .....	76		
Adjusting the Video Optic .....	78		



# 1. The ARRIFLEX 16SR 3 - System-Camera

The ARRIFLEX 16SR 3 is a 16mm/Super 16 camera designed to handle all modern production demands. It utilizes the full range of ARRIFLEX 535 mechanical, optical and electronic accessories.

- The format change from Normal 16 to Super 16 can be carried out with very few adjustments. An additional film gate is not necessary.
- Due to the 54mm PL lens mount, all commonly available lenses can be used. Lenses with a 41mm ARRI-bayonet-mount can be used with the single push-button release PL-mount-to-bayonet-mount adapter.
- The 16SR 3 time code capability offers access to all modern electronic post-production processes. The TC-generator has been integrated into the camera electronics and the time code recording unit is located in each magazine.
- The video-assist-system with the bright 1/2" color camera CCD 2-FR and the anti flicker processor AFP-2 for PAL or NTSC supplies a high quality, nearly flickerfree video images.
- As with the ARRIFLEX 535, the new bright viewfinder can be swung three-dimensionally. An automatic image compensator ensures that the frame remains upright and correct left-to-right regardless of the position in which the viewfinder is used. The horizontal finder image can be corrected when using the camera in difficult locations that do not allow the image to be viewed in the standard viewfinder positions.
- With ARRIGLOW, the ARRIFLEX 16SR 3's new illuminated frame viewfinder with continuously adjustable brightness, all format markings are clearly visible even in low light situations.
- The mechanically adjustable mirror shutter allows short exposure times and enables the use of HMI lights, even with older inductive ballasts.
- Coaxial magazines with and without TC-recording unit (time code) are available. 16 SR II-magazines can still be used (without TC-recording) on the ARRIFLEX 16SR 3.
- The HS version (high speed) of the camera is designed for speeds of up to 150 fps.
- The camera electronics incorporate a large, backlit, programmable LCD-Display advising the user of the

status and functions of the camera. The ARRIFLEX 16SR 3 provides for on-board speed selection and speed changes while the camera is running up to 1/1000 of a frame accuracy, without additional electronic accessories. Instant on-the-fly-changes between preselected standard on-board and programmed variable speeds are possible, as well as on-board phase shifting for filming of monitors.

- Accessory-interfaces enable the use of well-known ARRIFLEX system components such as
  - the camera control unit CCU-1
  - the external synchronization unit ESU-1
  - the lens control system LCS

### Symbols in the Handbook

 designates new methods of operation compared to the 16 SR II.

 refers to objects which are shown in photos.



## 2. Installation

### Packing and Transport

The camera should be stored in the sturdy ARRI transport case with the magazine attached, without the lens, the viewfinder extension, or the on-board battery. The video camera and the anti flicker processor should be removed for transport or shipping purposes. The AC/DC converter can stay on the camera. There are compartments for two on-board batteries and the viewfinder extension. An adjustable compartment enables storage of further equipment such as the bridge plate or an additional magazine. A compartment in the case lid is designed to hold the bridge plate support rods 440mm (19").

### Tripod Heads

The ARRIHEAD 2 with its compact construction is ideally suited to the ARRIFLEX 16SR 3. The hydro-heads ARRI 150 H, ARRI 150 M and ARRI 100 L can be used as well.

### Bridge Plate BP-6

The bridge plate allows quick mounting and balancing of the fully-equipped ARRIFLEX 16SR 3 system on the tripod.



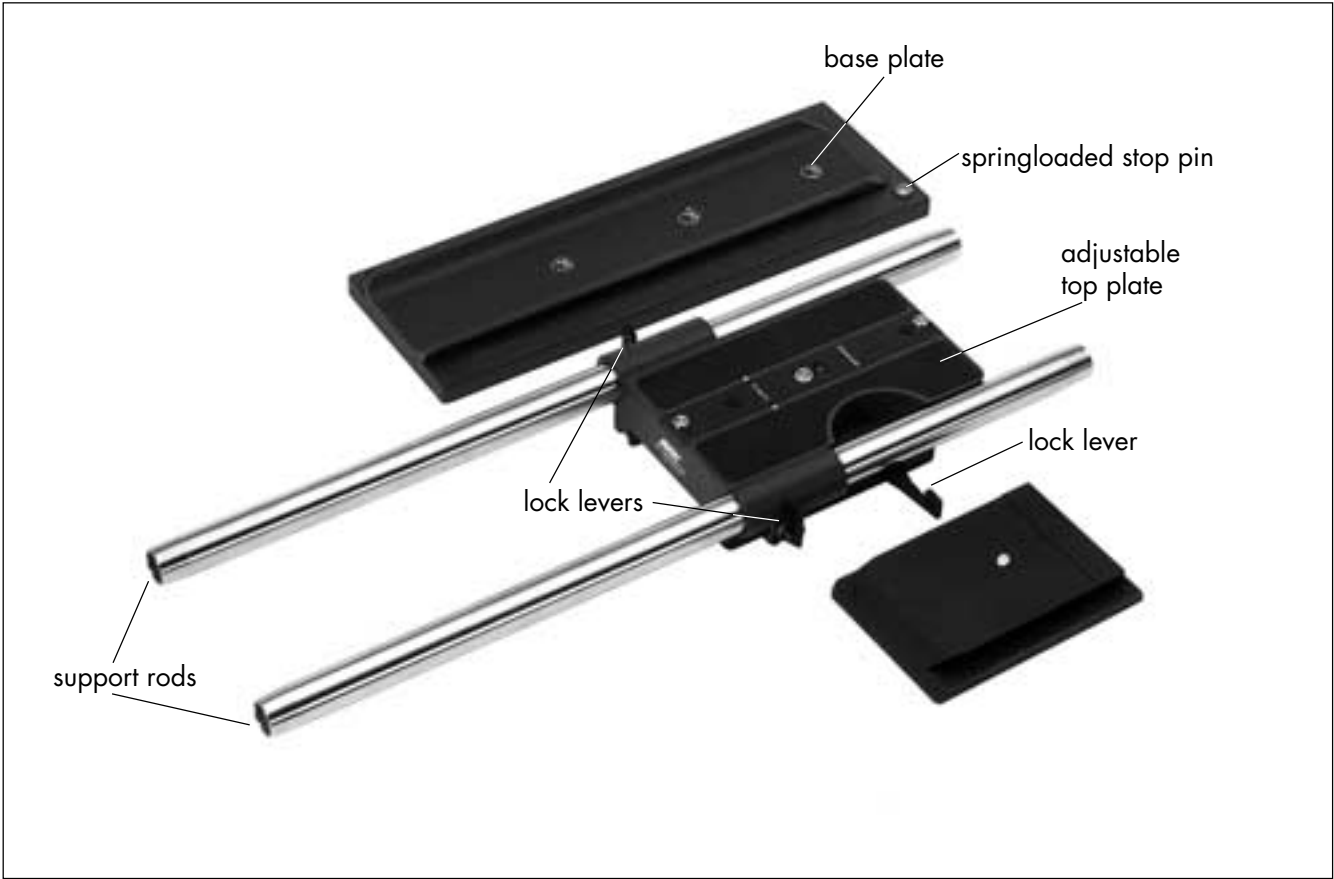

The bridge plate consists of the base plate [▶ picture](#), sliding upper plate [▶ picture](#) and support rods [▶ picture](#). The standard length of the support rods is 440 mm (19"). Support rods of 240 mm (9") length are available. A quickly attachable wedge plate allows mounting of the system without the base plate on the tripod or the ARRIHEAD 2.

For changing from Normal 16 to Super 16 the reversible, center-mounting plate on the upper sliding plate must be reversed to the appropriate position. See chapter 8.

For mounting see next page.



## Mounting

- Press in the spring-loaded stop pin  and pull the upper sliding backplate off the base plate .
- Attach upper sliding plate with the central tie-down screw (3/8" thread) to the camera base, ensuring that the locating pins align with the holes in the camera base.
- Screw the wedge plate of the tripod used onto the base plate .
- Lock the base plate onto the tripod head (spring-loaded stop pin rear).
- Slide the camera with the upper sliding plate into the dovetail guide of the base plate until the spring-loaded stop pin clicks audibly into position, preventing the camera from sliding to the back of the bridge plate.
- Slide the camera into the desired position and lock with the lock lever .
- Pull the support rods out to the desired length and set with the clamp screws .

## Balancing

- Fully equip the camera. Attach all camera and lens components you plan to use.
- Loosen the clamp lever on the upper sliding plate , balance the camera on the base and lock the clamp lever once the correctly balanced position is found.

## Bridge Plate BP-7 with 15 mm Support Rods

The bridge plate BP-7 with 15mm support rods can be transferred from Normal 16 to Super 16 optical positions. Old bridge plates with 15mm support rods for the 16 SR can subsequently be retrofitted with the new upper sliding plate. A conversion kit with instructions is available.

For mounting and operation see bridge plate BP-6.

For changing the upper sliding plate from Normal 16 to Super 16 optical center positions, the reversible center plate on the upper sliding plate must be reversed to the appropriate position. See chapter 8.

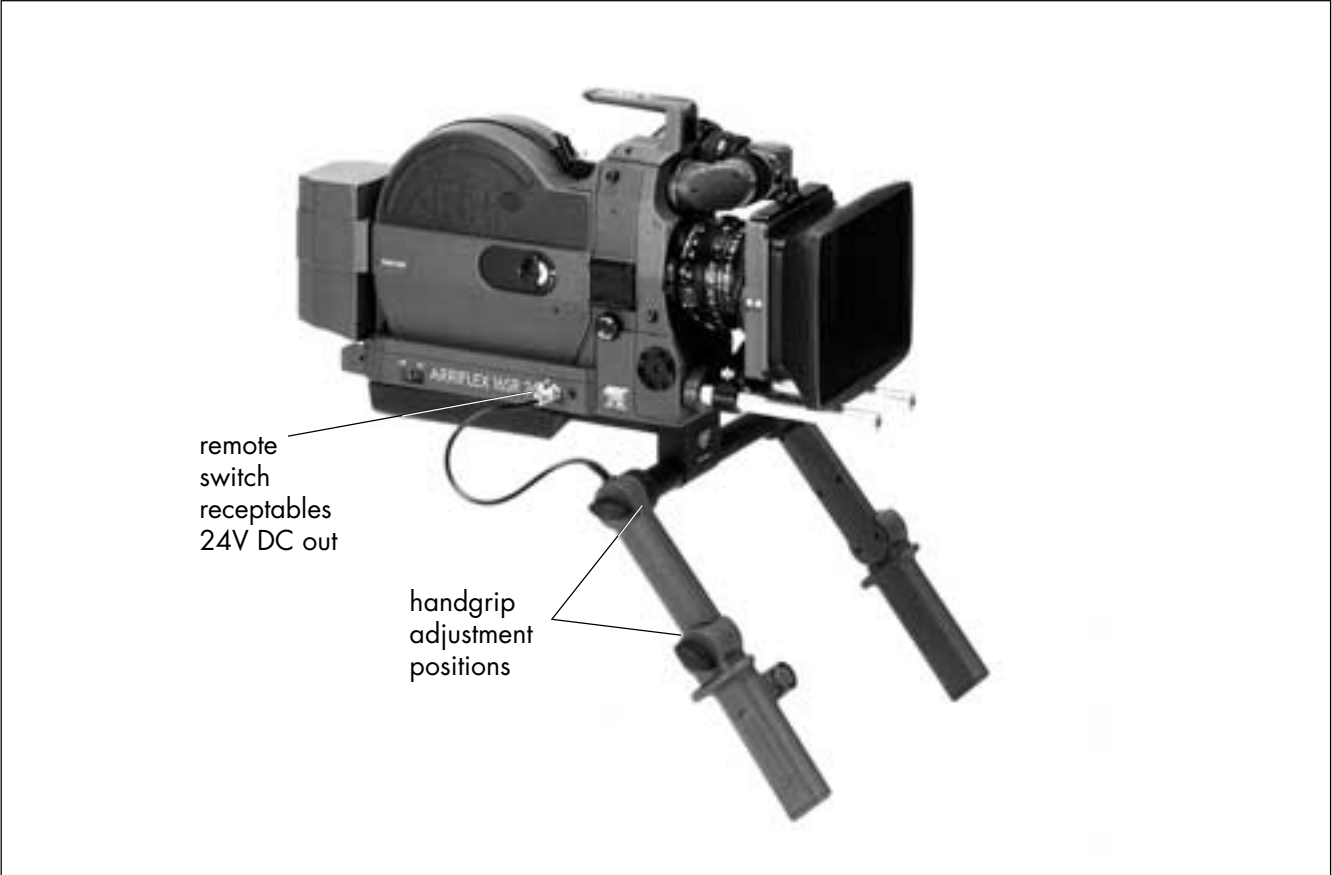



remote  
switch  
receptables  
24V DC out

handgrip  
adjustment  
positions

## Shoulder Set S-3

The shoulder set S-3 has adjustable grips and an integrated shoulder pad which allows comfortable hand-held camera operation.

### Mounting

- Attach the shoulder set with the central clamp screw into the tripod thread (3/8") on the camera base ensuring that the index pin on the shoulder set aligns correctly with the locating hole in the camera base.
- Adjust and position the handgrips on the shoulder set .
- Connect the cable to one of the RS-sockets  on the right side of the camera

## Camera Handgrip

The anatomically-shaped camera handgrip with the RUN push button is intended for shoulder operation. The shoulder pad can be used for more comfortable use of the camera on the shoulder.

### Mounting

- By turning the intermediate ratchet mounting ring, the angular outward position of the handgrip can be changed to the operator's personal fit.
- Attach the handgrip to the right rosette mount on the camera in the desired angle of inclination.
- Connect the cable to one of the RS-sockets  on the right side of the camera.



### 3. Power Supply

The camera is intended for use with 24 V DC. The acceptable voltage ranges are from 20 to 32 V DC. If the voltage drops below 18 V or rises above 34 V, a protective device prevents the camera from being turned on.

#### Changing the Fuses

Main fuse: 10 A Picofuse

Accessory fuse: 2,5 A Picofuse

- Remove the on-board battery or the power supply cable.
- Remove the magazine.
- Unscrew the cover FUSE on the electronic housing with a coin.
- Take a new fuse from the cover FUSE.
- Exchange the defective fuse using tweezers or a Hirschmann clamp. The accessory fuse is in the front, the main fuse at the rear.
- Rescrew the cover FUSE with a coin.

NOTE: In order to avoid future problems you should obtain replacement fuses as soon as possible. Fuses from other suppliers should be cut to size and bent as shown in the drawing on the right.

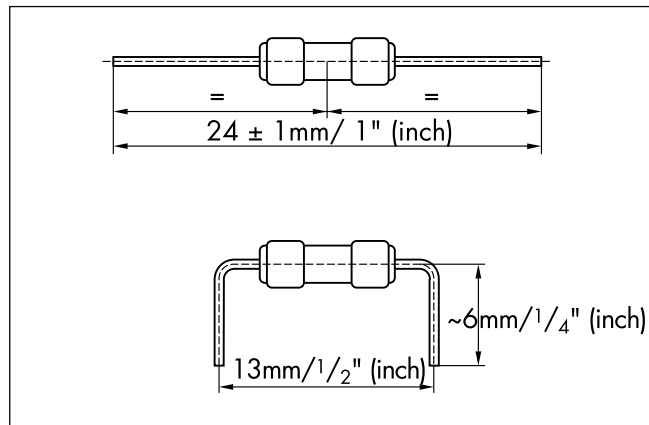
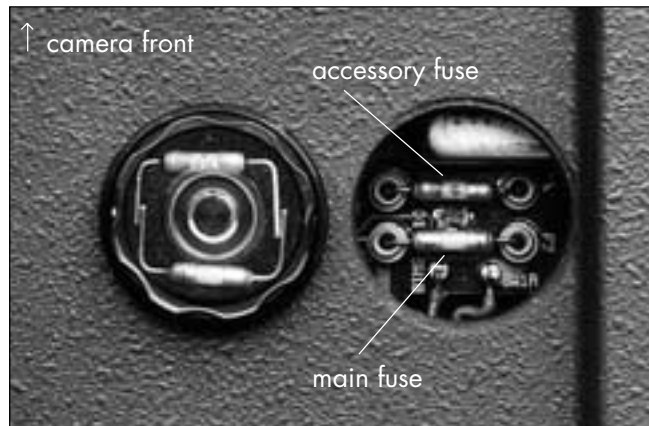

## On-Board Battery NC 24/1,2

Capacity 1,2 Ah. For mobile operation.

- Plug the on-board adapter into the BAT-socket and secure it with the knurled screw.
- Slide the on-board battery onto the on-board adapter and clip onto the magazine - the magnet holder keeps it securely in place.

## Battery NC 24/7 R

Capacity 7 Ah.

For use see product description NC 24/7 R.

- Connect the battery cable KC 20 or the coiled battery cable KC 29 into the BAT-socket on the camera.
- Make sure that the plug is locked in securely.



- Do not open the batteries!
- Charge batteries only with the ARRI charger!
- Do not bypass the fuse or temperature switch! (Danger!)
- Do not heat NC-batteries!
- Do not short-circuit NC-batteries!

## Charger NCL 24 R

For all 24 V batteries.

To charge the on-board batteries NC 24/1,2 the charger-adapter cable KC 38 is required.

For use see product description NCL 24 R.

## Double Charger NCL 24/1,2 SR3✓

To enable two on-board batteries to be charged simultaneously.

For use see product description NCL 24/1,2.

## Mains Unit NG 12/24 R

The mains unit is suitable for use in the studio. Its use is recommended when using electronic accessories with a higher power consumption (e.g. eyecup-heating, Video-Assist-System, Lens-Control-System). The mains unit has a safety switch-off device overheating and a power limiter.

For use see product description NG 12/24 R.



## DC/DC Converter 24V/12V-22W SR 3✓

The DC/DC converter 24V/12V-22W provides DC voltage for 12V accessories through the camera's power supply. The output voltage of the DC/DC converter is 12V +/- 1V, maximum power is 1,8 A.

The output plugs on the converter are wired as follows:

11-PIN Fischer Plug	
PIN 9	GND
PIN 11	+12 V

RS-sockets:

Two 3-pin Fischer plugs, parallel switching

RS-Sockets	
PIN 1	GND
PIN 2	+24 V
PIN 3	/ERUN

## Mounting

- Plug DC/DC converter with both plugs into the RS-sockets on the right side of the camera and secure with the knurled screw.

## 4. Magazines

Coaxial magazines with or without TC recording unit (time code) SR 3✓ are available. They are designed as quick-change magazines and use the same mechanical drive interface as previous 16SR systems.

For the HS camera (high speed) special HS magazines are available with or without the TC-recording unit.



Do not use HS magazines on the normal camera or standard magazines on the HS camera!

16 SR II-magazines can still be used (without TC-recording).

### Loop Protector

The loop protector protects the film loop and the pressure plate when the magazine is not attached to the camera. The loop protector should always be kept on the empty or loaded magazine until the magazine is attached to the camera. If the magazine is removed from the camera the loop protector should immediately be attached to it.



## Removing the Loop Protector

- Using slight pressure push the loop protector upwards.
- Swing out the lower side and remove the loop protector.

## Attaching the Loop Protector

- Engage the upper side of the loop protector from below into the pilot pin [▶picture](#) on the magazine.
- Swing the loop protector into the magazine, and with slight pressure push in to lock.

## Magazine Door

The magazine door can only be opened or closed if the magazine has been removed from the camera.

### Opening the Magazine Door

- Open the locking latch [▶picture](#).
- Hold down the red safety knob [▶picture](#) depressed and turn the locking latch to „A/O“.
- Pull on the locking latch to open the magazine door.

### Closing the Magazine Door

- Make sure that the locking latch is in position „A/O“.
- Push the magazine door firmly and turn the locking latch clockwise to the locked position - the safety knob locks audibly into place.

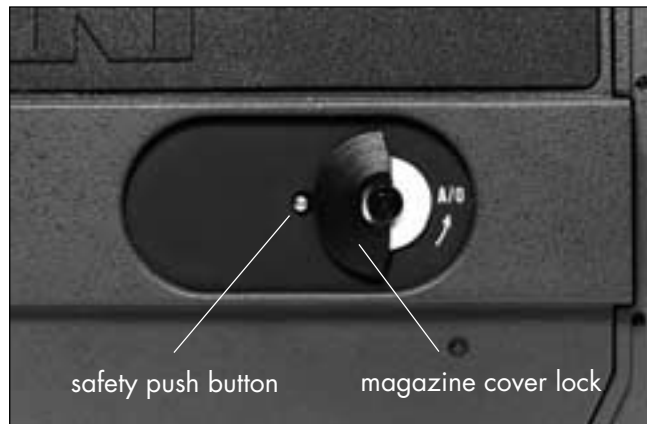

Never close the door when the locking latch is in position „closed“ as otherwise the latch could be damaged. Never hold the magazine by the door as otherwise the hinge could be damaged.

## Film Core, Core Holder and Clamp Core

A film core adapter [▶picture](#) and a collapsible core [▶picture](#) are supplied with the camera; these are placed on the supply and take-up film spindles.

The film is normally delivered on a core. The film core is attaches to the core adapter on the feed side. The core adapter is secured on the shaft with two clamp levers [▶picture](#) which automatically unlock when it is pulled off the shaft. On the take-up side the collapsible core is used. It usually remains on the shaft. The collapsible core can be pulled off easily once the lock [▶picture](#) has been opened. When the collapsible core is placed on the shaft it locks automatically in place.

## Cleaning the Magazines



Keep the inner side of the magazine extremely clean! Clean the magazine every time you load or unload it. Use only an optic brush!

- Swing away the guide roller arm back [▶picture](#) until it clicks - do not pull the guide roller arm upwards.
- Clean the glass window for the film end sensor on the under side of the magazine with an optic cloth and cotton buds. If very dirty moisten the optic cloth with pure alcohol.

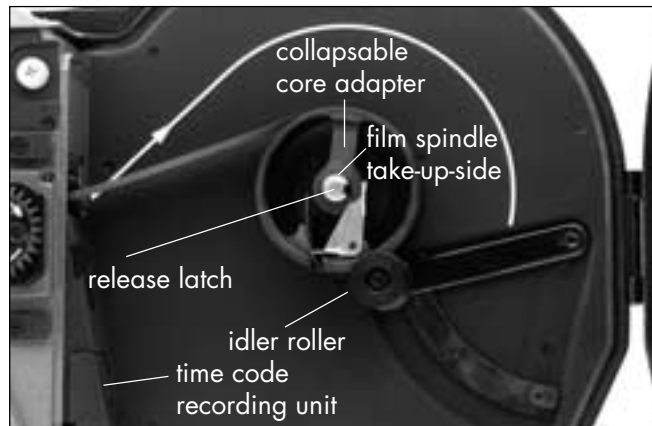
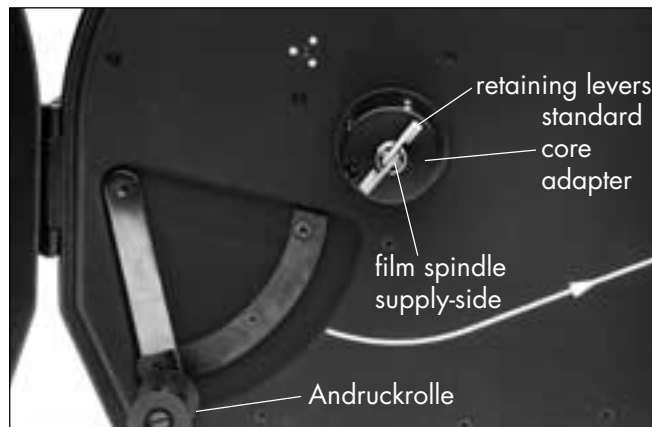

## Cleaning the TC-Magazine

- Open out the lens on the recording unit [▶picture](#).
- Clean the upper side of the lens with an optic cloth.  
If very dirty, moisten the optic cloth with pure alcohol.
- Clean the under side of the lens with cotton swabs.
- Clip the lens holder.

If an empty film core is installed on the feed side pull it straight off the core adapter. If the film core is too tight on the core adapter, remove both from the film spindle. Open the retaining latches and pull the core adapter with the film core off the spindle, and separate the two outside of the magazine. Before loading the magazine with film, install the core adapter and lock the retaining latches.

## Loading the Magazine

The film must be loaded with the emulsion side inwards. With single perforated film only B winding can be used.

If the user is not familiar with the magazine it is recommended before placing it in the changing bag that they become familiar with the following:

- the position of the opening for loading the film,
- the feed direction of the film in the magazine and
- the position and turning direction of the gear clockwise.

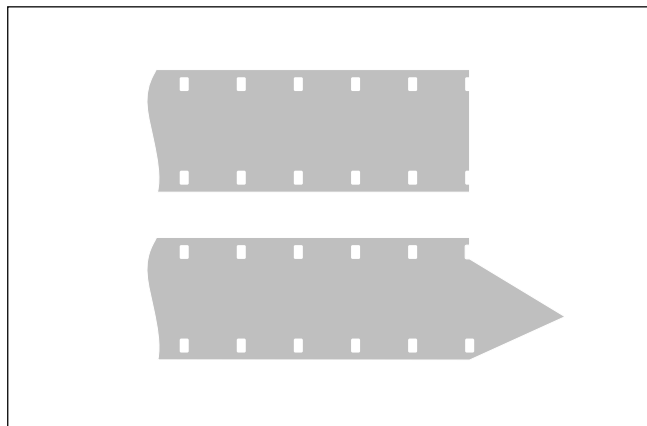

### Film Head

Regardless of how the film head is cut, the film can always be loaded. Optimal for loading is a straight cut through the perforation holes. When cutting the film ensure that no remains of the film fall into the magazine as they could cause scratches on the film, damage to the equipment or a film jam.

## Preparations

- Remove the tape seal from the film container.
- Place the closed film container and the magazine without the loop protector in the changing bag.
- Place the magazine with the feed side up.
- Open the feed side of the magazine.
- Close the changing bag and place your hands in the sleeves.

## Changing Bag

- Open the film container in the closed changing bag.
- Remove the black film wrapper.
- Remove the tape from the film end.



Ensure that the tape is completely removed.

- Stick the tape to the outside of the film container in order to check later that no remains of tape are stuck to the film.
- Close the empty film container and lay the film roll on top of the container to facilitate threading the film. Then place the film roll and the feed slot on the same height, ensuring that the film roll feeds in as marked on the magazine.
- Slide back the guide roller arm until it clicks in the open position - do not pull the guide roller arm upwards.

## Loading the Film, Feed Side

- Feel for the opening for threading.
- Guide the film head into the opening and carefully push it further into the opening. Simultaneously feel on the gear when the film engages with the internal sprocket.
- Be sure that dual perforations is correctly loaded (emulsion side inward, B winding).
- Carefully turn the gear further in the direction of the arrow (clockwise) until the film emerges from the magazine throat.
- Pull some of the film out of the magazine throat.



If the film cannot be loaded at the first attempt, cut off a piece of film and try again. Never use force!

## Attaching the Film Roll

- Hold the film roll over the center of the shaft.
- Place the film on the shaft and push the core as far as it will go onto the core adapter, without pressing on the film. The film will otherwise become conical and cause noise during operation.
- The spring on the core adapter can be locked into the groove in the film core by turning the film core on the core adapter.
- Ensure that the film core is locked in place.
- Carefully place the guide roller arm on the film roll.
- Ensure that the guide roller is centered and guides the film roll on both sides.





This is the most common error! Therefore check again whether the guide roller arm is sitting correctly. The mechanical film counter will not work if the guide roller arm is not pushed onto the film roll.

- Pull the film roll tight with the magazine drive gear.
- Ensure that the cover locking latch is completely open.
- Carefully close the magazine door, ensuring that none of the film is hanging out or gets caught or crimped. After closing the magazine door feel with one finger around the door to make sure that no piece of film or any part of the changing bag is stuck in it.
- Lock the magazine cover with the locking latch.
- Ensure that the magazine cover is closed and locked.
- Open the changing bag and take out the magazine.

### Forming the Film Loop and Threading the Film, Take-Up Side

- Remove the magazine from the changing bag or dark room, and place it with the magazine cover hinge-side down (rear of magazine).
- Pull some film out of the magazine throat and place along the under side of the magazine, pulling it until the first perforation hole reaches the white index line. The film should be slightly tight. The film is guided at a slight diagonal rather than straight against the

pressure plate.

- Hold the gear to keep the loop length stable. Push the film head  gently into the smooth take-up channel  (picture next page) until it engages with the take-up sprocket.
- As soon as the film engages noticeably with the take-up sprocket, turn the magazine drive gear approximately 5 further revolutions in the direction of the arrow.
- If the film loop is too large or too small repeat the process.



Do not use force! In the case of difficulties repeat the process carefully.



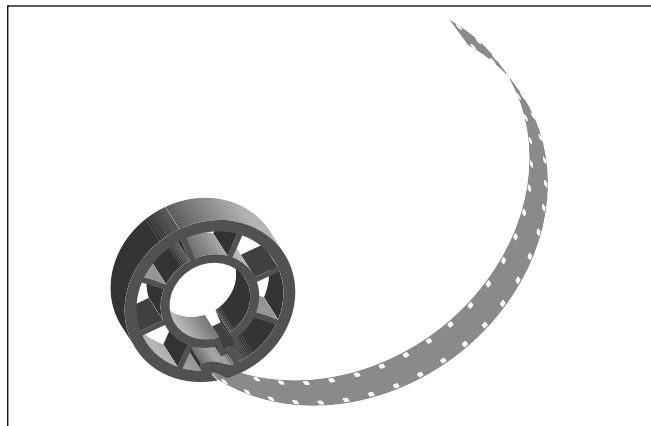

## Attaching the Film to the Core Adapter or the Collapsible Core

- When in daylight place the magazine with the take-up side facing up.
- Open the take-up side of the magazine cover.
- Swing back the guide roller arm until it clicks in the open position. Do not pull the guide roller arm upwards.
- Pull out some film.
- Attach the core adapter or the collapsible core onto the take-up shaft.



Collapsible core:

- Slide the film head into the opening of the collapsible core. The film head should be pushed a little past the metal tongue of the clamp lever. If the film head is pushed too far into the collapsible core, unwanted noise may be heard.
- Lock the clamp lever. Ensure that the film is clamped straight and at the right height. If the film is clamped at a slant or too high in the collapsible core, unwanted noise may be heard.

Core holder:

- Place the core adapter on the film core, paying attention to the direction of the slot (picture left).
- Place the film head in the slot.
- With a fingernail, smooth out the film where it emerges to avoid uneven movement of the guide roller arm.
- Feed with the gear approximately 5 revolutions clockwise until the film is sitting securely.

The film can be secured on the core holder or the clamp core before placing this on the shaft.

### Final Tasks

- Carefully place the guide roller arm on the film roll.
- Ensure that the guide roller is centered, and guides the film on both sides.

- Carefully tighten the film between the clamp core and the gear: hold the gear firmly and turn the core holder further.
- Clamp core: turn the gear by hand a few revolutions further. Loosen the clamp on the clamp core. Carefully push on the film reel to ensure that the film reel is sitting at the correct height. Retighten the clamp.
- Turn the gear a few revolutions further by hand, checking the even movement of the guide roller arm.
- If using TC-magazines set the sensitivity: turn the desired value upwards. See the table, chapter 12.
- Close and lock the magazine cover.
- Ensure that the magazine cover is closed and locked.
- Check the counter on the magazine. The white indicator must be visible, otherwise the guide roller arm is not locked. The counter now shows the amount of unexposed film on the feed side.
- Hang the film loop between the 4 guide pins (2 shaped as claws).
- Center the film loop in the direction it will run.
- Attach the loop protector.

## Unloading the Magazine

### Preparations

- Remove the loop protector.
- Check the counter on the magazine. It must show 0, otherwise the film has not been fully exposed.
- Open the feed side in daylight.
- Swing away the guide roller arm until it clicks - do not pull the guide roller arm upwards.
- Pull off the core of the exposed roll.
- If further shooting is to be carried out, the unexposed film can now be loaded on the feed side.

### Tasks in the Changing Bag

- Place the magazine with the take-up side facing upwards, the empty film container and the black film wrapper in the changing bag.
- Close the changing bag and place your hands in the sleeves.
- Open the magazine cover on the take-up side.
- Swing away the guide roller arm until it clicks. Do not pull the guide roller arm upwards.

### Collapsible core:

- Loosen the clamp on the collapsible core.
- Holding the shaft down with your thumbs, brace your thumbs on the film spindle and pull off the film carefully.

### Core adapter and film core:

- Unlock the film core.
- Brace your thumbs on the film spindle and carefully pull off the film with the core adapter and film core.
- Carefully press the core adapter out of the film core, ensuring that the inner loops of film are not pressed out with it, and place the core adapter back onto the film spindle.
- Place the film in the black wrapper and place this in the film container.
- Lock the film container and seal it down with the tape.
- Open the changing bag.

### Final Tasks

- Clean the pressure gate in the magazine throat with an optic brush and an optic cloth. If very dirty, moisten the optic cloth with pure alcohol.
- Clean the magazine (see above).



Never remove film deposit with metal tools; use only the ARRI plastic film track cleaning rod.

## 5. Camera Body

With the new pitch adjustment you can adjust the camera to optimize the running noise level when different types of film stock are used. The mechanically adjustable mirror shutter enables shorter exposure times and allows use of HMI-lights, even with older ballasts.

### Movement

The kinematic film-movement with pitch adjustment is designed for extremely quiet running. The registration pin guarantees optimal image steadiness. Speed can be set between 5 and 75 fps (with HS between 5 and 150 fps).

### Checking Film Transport

- With the magazine attached depress the PHASE key – the camera will run slowly (1 fps). This is recommended every time a loaded magazine is attached to the camera to assure correct film transport.



### Pitch Adjustment SR3✓

With the pitch adjustment you can adjust the camera to optimize the running noise level of the camera at standard speed using a variety of different types of film stock.

- Let the camera run at the desired standard running speed.
- Set the hexagon key SW 2 (key width 2 mm) into the pitch adjustment [▶picture](#).
- By pressing, engage the pitch adjustment with the key, and by turning the key, select the position that optimizes the camera noise level.

## Mirror Shutter

**SR3✓** The open sector of the mirror shutter can be mechanically adjusted while the camera is disconnected. The opening angles are 45°, 90°, 135°, 144°, 172.8° and 180° and are marked on the moveable shutterblade. The selected shutter opening locks into its position. The selected shutter opening angle is also shown on the camera display when depressing the PHASE key in Standby (for longer than 1 sec.). An automatic stop position guarantees an undisturbed view through the viewfinder, once the camera is stopped.

If the film gate needs to be checked through the lens port, release PHASE pushbutton quickly after activating it in Standby. The mirror shutter will then remain in the open position for the gate check. Once the check is completed, press the Phase pushbutton briefly, and the shutter will return to its viewing position.

### Manual Inching Knob

- To turn the mirror shutter and movement manually, press the manual inching knob and turn this in the direction of the arrow on the side of the camera.

### Adjusting the Mirror Shutter Opening **SR3✓**

Necessary tool: special key (2mm hexagonal driver)



located in the hidden compartment above the heated eyecup connector.

- Switch off the camera and remove the on-board battery or the supply cable.



If the camera is accidentally switched on while the special key is attached, the mirror shutter could be damaged. Therefore switch off the camera and remove the on-board battery or the supply cable!

- Remove the lens or the lens opening cover.
- If appropriate, remove the PL/bayonet-mount adapter.

- Using the manual inching mechanism adjust the mirror shutter so that the adjustment screw for the shutter adjustment  is visible at the bottom of the lens mount, below the mirror shutter.
- Insert the special key into the adjustment screw.
- In Standby, depress the PHASE pushbutton until the wide angle symbol appears in the display. After approx. 1 sec. the selected opening-angle will be shown in the upper line of the display.



The mirror shutter can be damaged if the special key with the protective rubber covering is not used!

- By pressing, engage the adjustment screw with the special key and hold the mirror shutter with the manual inching mechanism in its position. While enlarging the opening angle it is possible to support the mirror shutter on the special key, in which case it does not need to be held in position by the manual inching mechanism.
- Set the desired opening-angle of the mirror shutter with the adjustment screw (to reduce the angle turn counter-clockwise, to enlarge the angle turn clockwise). While adjusting the shutter angle, the shutter can also be held with your finger in the black center, preventing it from turning while adjusting the angle. Be sure not to touch the mirror area of the shutter.

### Checking the Mirror Shutter Setting

The setting of the mirror shutter can also be checked with a lens in place.

**1.37 – TV 1.33**

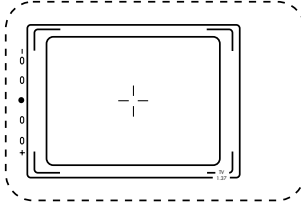

**TV 1.33**

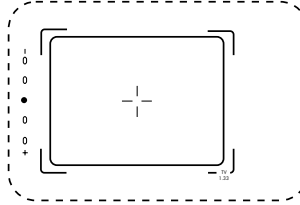

**1.37**

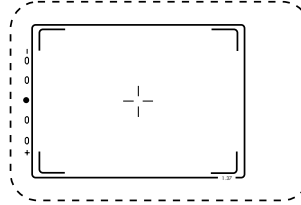

**1.85 (S16) – TV 1.33/1.78**

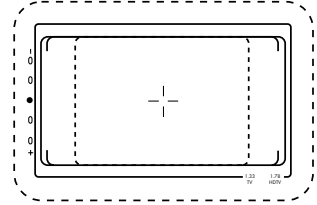

**1.66 (S16)**

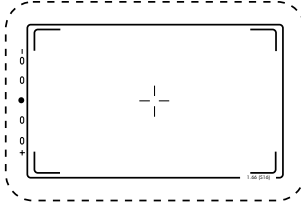

**1.66 (S16) – TV 1.33**

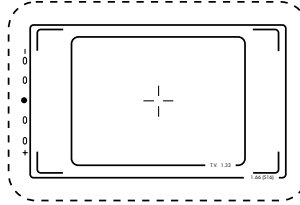

**HDTV 1.78 – TV 1.33**

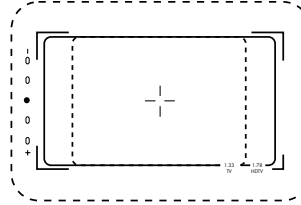

**1.85 (S16)**

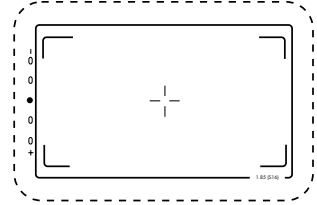

## Fibre Optic Viewing Screens

The overview shows the available fibre optic viewing screens. Without ARRIGLOW, the fibre optic viewing screens for the ARRIFLEX 16 SR II can be used. (The 16SR 3 screens can also be used in the 16SR II as well).

### Changing the Fibre Optic Viewing Screens

- Switch off the camera and remove the on-board battery or the supply cable.
- Remove the lens or lens port cap.
- If appropriate remove the lens port adapter.
- Turn the mirror shutter downwards using the manual inching mechanism.
- Grip the fibre optic viewing screen using the Hirschmann-clamp (included in the camera package) and pull out of the holder.
- To clean the fibre optic viewing screen use a particle-free optical cloth moistened with pure alcohol.



Before reinserting the fibre optic viewing screen ensure the fibre optic viewing screen frame is completely clean.



- Push the fibre optic viewing screen with the Hirschmann-clamp to the stop position in the holder. A spring lock fixes the fibre optic viewing screen in the exact position.
- Check the lock: press a finger carefully onto the front rim of the fibre optic viewing screen frame.



## Attaching the Magazine onto the Camera



Do not use HS magazines on a standard camera or standard magazines on a HS camera.

- If appropriate press the button  on the video carrying handle and swing the handle to the left side of the camera.
- If appropriate swing back the on-board battery.
- Remove the loop protector and the aperture cover plate.
- Center the film loop in reference to the pressure plate, and make sure the film is held in place by the four guide pins.
- Flip the safety latch to the back .
- Grasp the upper part of the magazine and hold it on approx. 30° slant (two o'clock) position.
- Push the pilot pin  on the magazine forwards into the camera housing.
- Carefully press the back part of the magazine downwards until it locks in place.



**SR 3** ✓ The red markings on the casing should no longer be visible!



- Flip safety lever  to the front.



- Check that magazine is locked securely by lifting the back part of the magazine.
- If appropriate swing back the on-board battery and the video carrying handle.
- Set the film sensitivity on the camera's exposure meter and reset the film counter.
- Check the TC sensitivity setting on the magazine.



## Removing the Magazine

- **SR 3✓** Press the button  on the video carrying handle and swing the handle to the left side of the camera.
- If appropriate swing back the on-board battery.
- Flip the safety lever  to the back.
- Grasp the upper part of the magazine.
- Press down the release lever with the index finger.
- Swing the magazine 30° upwards (two o'clock) and pull it backwards until it is removed.
- Clean the aperture plate with an optical brush and an optical cloth. Do not use solvents!
- Attach the loop protector to the magazine and the aperture cover plate to the camera.



Never remove emulsion buildup with metal tools; only use ARRI plastic rod.

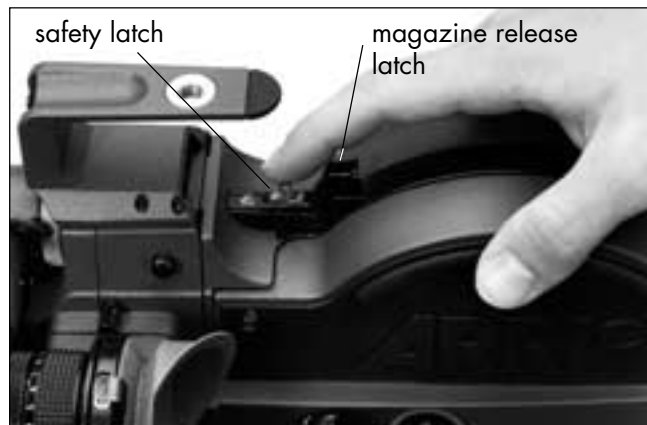

## 6. Optics

### Lenses

**SR3✓** The ARRIFLEX 16SR 3 has a 54mm PL-mounting flange (positive locking). Lenses with a 41mm ARRI-bayonet can be used with a lens port adapter. All commonly used 16mm and 35mm lenses with an ARRI mount can be used.

The following lenses can be used with the Super 16 format:

16mm lenses (with 41mm ARRI bayonet mount)

- 11-66mm Angenieux T2,6
- 11,5-138mm Angenieux T2,3
- 15-150mm Angenieux T2,3
- 16-44mm Angenieux T1,3
- 10,4-52mm Cooke Varokinetal T2,8
- 10-30mm Cooke Varokinetal T1,5

16mm lenses (with 54mm PL-mount)

- 11-110mm VARIO SONNAR T2,2 (also available with 41mm ARRI bayonet-mount)
- 12mm Zeiss Distagon T1,3
- 16mm Zeiss Distagon T1,3
- 25mm Zeiss Distagon T1,3
- 50mm Zeiss Planar T1,3

High speed 35mm lenses (with 54mm PL-mount)

- 18mm Zeiss Distagon T1,3
- 25mm Zeiss Distagon T1,3
- 35mm Zeiss Distagon T1,3
- 50mm Zeiss Planar T1,3
- 65mm Zeiss Planar T1,3
- 85mm Zeiss Planar T1,3

35mm prime lenses (with 54mm PL-mount)

- 10mm Zeiss Distagon T2,1
- 12mm Zeiss Distagon T2,1
- 14mm Zeiss Distagon T2,0
- 16mm Zeiss Distagon T2,1
- 20mm Zeiss Distagon T2,1
- 24mm Zeiss Distagon T2,1
- 28mm Zeiss Distagon T2,1
- 32mm Zeiss Planar T2,1
- 40mm Zeiss Planar T2,1
- 50mm Zeiss Planar T2,1
- 60mm Zeiss Macro T3,0
- 85mm Zeiss Planar T2,1
- 100mm Zeiss Planar T2,1

- 135mm Zeiss Planar T2,1
- 180mm Zeiss Sonnar T3,0
- 300mm Zeiss Tele-Apotessar T3,0
- 600mm converter for Tele-Apotessar T6,0

35mm macro lenses (with 54mm PL-mount)

- 16mm ARRI MACRO T2,1
- 24mm ARRI MACRO T2,1
- 32mm ARRI MACRO T2,1
- 40mm ARRI MACRO T2,1

The following lenses can only be used if the viewfinder arm is set vertically:

- 50mm ARRI MACRO T3,0
- 100mm ARRI MACRO T3,3
- 200mm ARRI MACRO T4,3

All 35mm lenses with a 41mm ARRI bayonet-mount can also be used for Super 16.

The following lenses cannot be used for Super 16 format:

- 10-100mm VARIO SONNAR T2,0 (use instead the 11-110mm VARIO SONNAR T2,2)
- 8mm DISTAGON T2,1
- 9,5mm DISTAGON T1,3

Lenses with an automatic spring-loaded diaphragm can be used. Shutter control will NOT work.



16mm and 25mm Schneider lenses of the old construction-type (41mm aluminium-mount) should under no circumstances be used as this could destroy the mirror shutter!

Heavy lenses, such as some zoom and telephoto lenses should only be used with a support.

When using lenses or the PL/bayonet adapter, lens mount surfaces must be kept clean. After removing the lenses, immediately replace with the protective cover or another lens to prevent dust or dirt from entering the camera.

## 54mm PL-Mount SR 3✓

The bayonet lock on the PL-mount guarantees secure fastening of all lenses, including heavy lenses. An accurate index pin [▶picture](#) in the lens mount assures precise mounting of the lens. Four precise index slots in the lens mount on the lens to be attached at a 90° direction.

### Attaching the Lens

- Open the bayonet lock [▶picture](#).
- Push the lens straight line into the lens mount receptacle and hold firmly in place.
- Check the mounting position of the lens.
- Ensure that the index pin on the camera side [▶picture](#) is positioned into one of the four slots on the lens mount.
- Lock the bayonet ring firmly clockwise. Don't overtighten.

### Removing the Lens

- Hold the lens and open the bayonet lock [▶picture](#) ring counterclockwise.
- Pull the lens straight out of the camera.
- Immediately replace the protective cover or another lens.

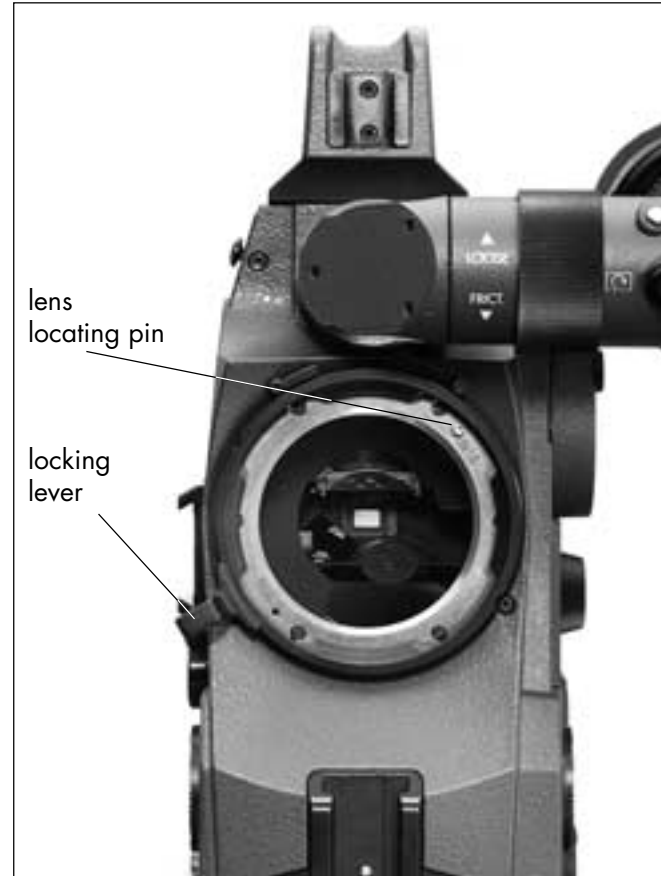

## 41mm ARRI Bayonet

Lenses with a 41mm ARRI bayonet mount can be used with a PL/bayonet adapter. When changing bayonet mount 41mm lenses, the adapter remains on the camera. Release the bayonet lock of the adapter by pushing the little back release pushbutton on the side of the camera.

### Attaching the PL/Bayonet Adapter SR3✓

- Open the bayonet lock [▶picture](#).
- Push the adapter [▶picture](#) in a straight line onto the lens mounting receptacle.
- Ensure that the index pin on the camera side [▶picture](#) is positioned into the index slot on the adapter.
- Lock the bayonet ring.

### Attaching the Lens

Only lenses with a 41mm bayonet mount can be used.

- Push the lens straight into the adapter.
- Lock the lens into the adapter by turning clockwise.

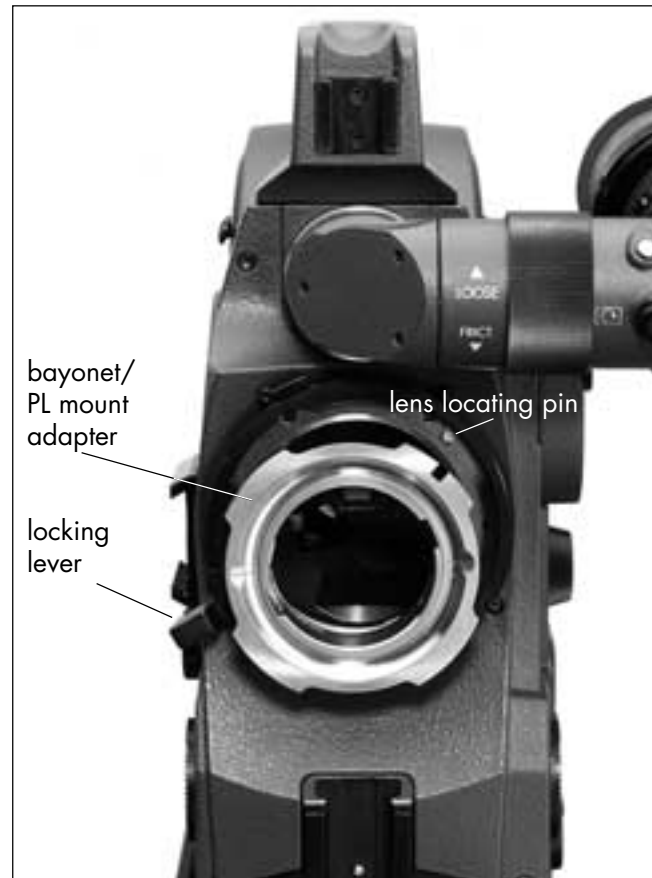

## Removing the Lens



The adapter remains on the camera.

- Press in the release button completely.
- Unlock the lens by turning counter-clockwise.
- Pull the lens straight out of the adapter.
- Immediately replace the protective cover for the compensation adapter or another lens.





## Removing the Lens Port Adapter

- Open the bayonet lock.
- Pull the adapter straight out of the camera.
- Immediately replace the protective cover or another lens.

## Lens Support

When heavy lenses are used install the lens support. To support heavy lenses, the lens support bridge LS-7  and a support ring  which is compatible with the lens has to be installed.

### Attaching the Lens

- Mount the support ring  on the lens. This is usually done only once. The support ring then remains on the lens.
- Place the lens support  from above on the support rods and with slight pressure let it click in.
- Attach the lens to the camera and hold it firmly in place.
- Push the lens support under the support ring.
- Tighten down the knurled knob  and pull tight the clamp lever on the lens support .

The clamp lever  can be locked in different positions:

- Unlock the clamp lever by pulling it outwards and turn to the desired position.

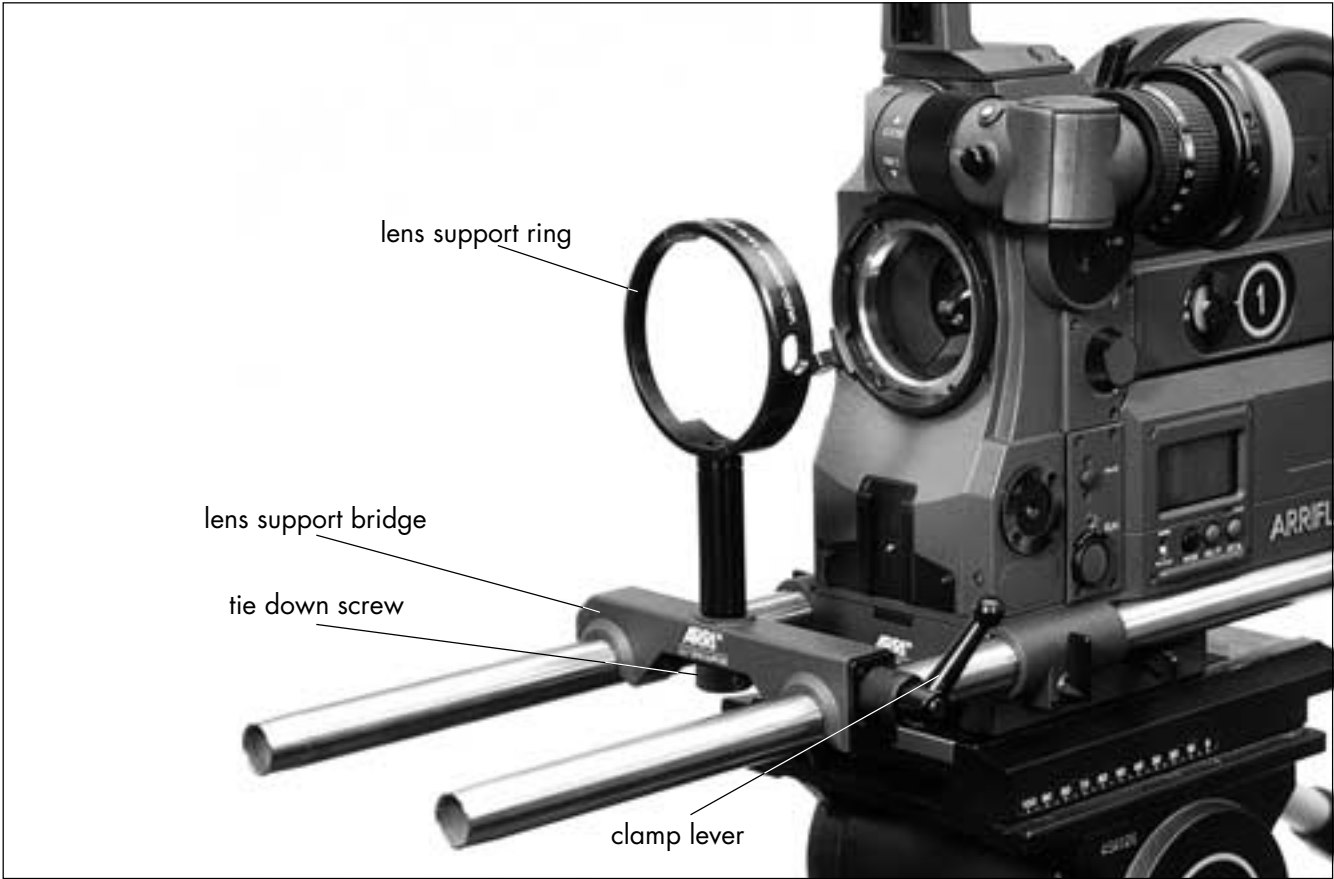

lens support ring

lens support bridge

tie down screw

clamp lever

## Viewfinder

The viewfinder can be swivelled three-dimensionally. It can be swung over approx. 190° from the left to the right side of the camera, with an attached video-assist-system approx. 120°. The viewfinder can be rotated 360° and can be swivelled a further 25° outwards for left eye viewing. An automatic image compensator provides an image which is upright and correct left-to-right. Only when it is swivelled outside of the main axes is there an image distortion which however can be fully compensated by the new manual image compensator.

### Warning Signals in the Viewfinder

Asynchronous camera operation: LED lights up  
Low voltage: LED flashes

### Friction

The viewfinder is held in position by friction. To adjust viewfinder arm friction for 360° positioning:

- To reduce friction turn the adjustment ring  in the direction LOOSE.
- To increase friction turn the adjustment ring in the direction FRICT.

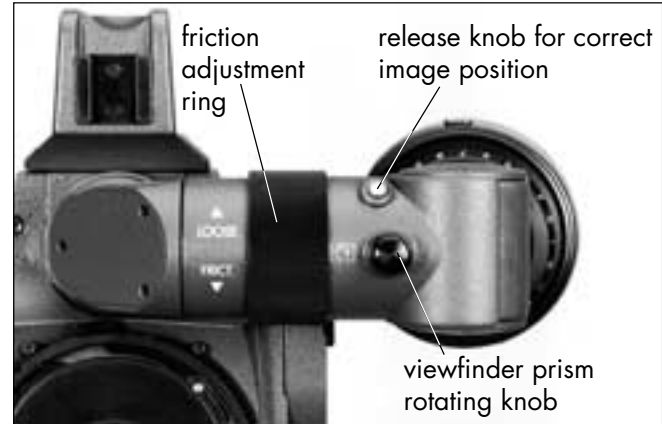

If friction in the left-right swivel and the 25° swivel



gradually decreases it should be reset. See chapter 13.

### Viewfinder Image Correction SR 3✓

If the viewfinder is used in other than the customary position, the viewfinder image can be adjusted for more convenient viewing comfort:

- To correct the image position, push the release button  and correct the image with the rotary knob . Internal friction will hold the corrected image position in place.



The above option allows unrestricted correction of the finder image.

## Eyepiece

The diopter compensation on the eyepiece is fitted with a scale of 1 to 12. At position 6 middle focus is set.

### Unscrewing the Eyepiece

- Loosen the knurled ring [▶picture](#).
- Pull off the eyepiece.

### Screwing on the Eyepiece

- Attach the eyepiece to the finder.
- Ensure that the pin locks into a groove.
- Pull the knurled knob [▶picture](#) tight.

## Eyecup

In order to avoid light falling in through the viewfinder the eyecup has a shutter.

- Always slide the shutter closed [▶picture](#) when not using for viewing.

The eyecup can be removed and replaced by the heated eyecup. See chapter 7.

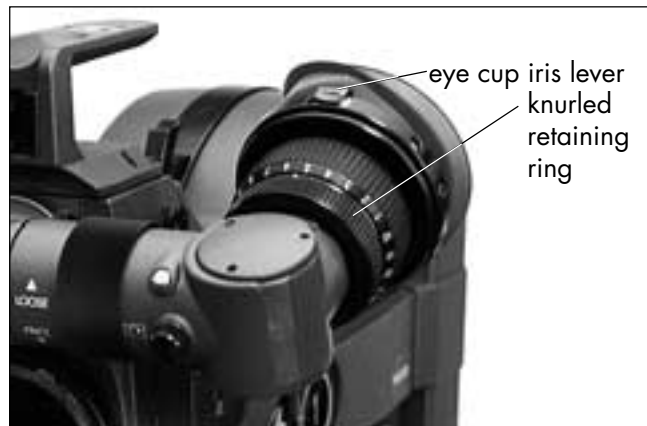



accessory shoe

tie down screw

## 7. Optical Accessories

### Light-weight Support LWS-2

The light-weight support is necessary if using the light-weight follow-focus device and for the 4"x4" matte box MB-17. The light-weight follow focus device and the 4"x4" matte box MB-17 are pushed onto the rods on the light-weight support and then clamped.

The light-weight support can also be used as a support for VARIO-SONNAR lenses - particularly when using the Zeiss Mutar tele-converter, the light-weight follow focus device or the LCS.



If using the 8mm Distagon, the extensions on the light-weight support should be removed. These would otherwise be visible in the frame.

For format change from Normal 16 to Super 16 the flange on the light-weight support should be turned 180°. See chapter 8.

#### Mounting

- Loosen completely the locking screw .

- Place the flange from above into the camera shoe  (side downwards).
- Press the light-weight support against the camera so that the guide pins connect with the appropriate holes in the light-weight support.
- Retighten the locking screw.
- If appropriate, screw the extensions on or off.

#### Dismounting

- Loosen completely the locking screw  so that the guide pins on the camera pull out of the holes on the light-weight support.
- Pull the light-weight support upwards and off.

#### Using VARIO-SONNAR Lenses

- Mount the light-weight support.
- Remove the rubber ring from the lens.
- Mount the support ring on the lens.
- Push the lens support LS-6 onto the light-weight support.
- Attach the lens to the camera.
- Push the lens support under the support ring.
- Screw tight the knurled screw on the lens support.





## Universal Follow Focus Device FF-3







With the Universal follow focus device the operator can focus the lenses from his working position. He uses the follow focus knob or a flexible shaft to focus. This can be attached on the left or the right side. The switchable step-down gear allows the lens to be optimally adapted to the scene. The Universal follow focus device can be used on prime and zoom lenses. Mounting is also possible if the matte box or other accessories are attached. Markings can be made on and removed from the marking disks. The groove and pin ensure that the markings can be reproduced.

### Mounting

Depending on the lens used, the adjustable arm can be swung onto the lens geared ring from above or below, and the gear shaft can be attached from in front or behind.

- Snap the Universal follow focus device onto the support rods.
- If appropriate mount the lens support.
- Attach the lens and turn the follow focus ring to infinity.
- Attach the gear  to the swing arm  from in front or behind and fasten with the knurled knob .
- Slide the follow focus device onto the support rods and swing the swing arm onto it so that the gear shaft locks into the toothed drive ring on the lens allowing

no free play.

- Set the swing arm in place with the locking screw .
- Clamp the follow focus device onto the support rods with the locking lever .
- Check for play by turning the follow focus device  in both directions.
- If appropriate reset: loosen the clamps from the follow focus device and loosen the swing arm, reset the play and retighten the clamps.
- For use from the right side: attach the right-hand focus knob and fasten with the locking knob .
- When using some short focal range lenses, the extension included with the device should be mounted on the right side of the follow focus device. The focus knob is then attached to the extension.
- The follow focus lever which is included with the device can be attached left or right on the focus knob.
- If using a flexible shaft: slot in the shaft right or left on the focus knob. Set up the focus knob at the other end of the shaft.
- Turn the marking disk  into the desired position and fasten with the knurled knob .

The locking lever  can be fastened in various positions:

- Pull the locking lever outwards and turn in the desired direction.

### Changing the Step-Down Gear

When the focus knob is pushed in the step-down ratio is 1:1, when the focus knob is pulled out the ratio is 1:0,6.

- Depress the button  and simultaneously pull the focus knob out to the stop position, or push it in - the gear will be engaged or disengaged.

See also the information sheet „TECHN. INFORMATION Universal Follow Focus Device“.

### Light-Weight Follow Focus Device

The light-weight follow focus device is attached to the light-weight support and fulfils the same function as the Universal follow focus device. The light-weight follow focus device can only be used from the left side.

### Lens-Control-System LCS

The LCS is a versatile control unit for all commonly used lenses. As a compact, modular system it can be expanded from the basic zoom control to a complete remote control system for zoom, focus and iris. An optional memory module stores set values and replays operation functions. This data can be stored through the RS232 interface on a computer and reloaded into the memory module.

See the instruction manual Lens-Control-System.

## 4"x4" Production Matte Box MB-16

The 4"x4" production matte box is equipped with two rotatable filter stages for two 4"x4" push-through filters. The filter stage has a receptacle at the rear for 4 1/2" diameter filters and a reflex protection ring. It is interchangeable with other filter stages. Optional 4"x5,650" or 4"x6" filter frames with gearing for graduated filters can be used by means of a rotary knob or the flexible drive. French flags can be firmly secured with the enclosed holder. Lenses down to a focal range of 8 mm can be used.

The 4"x4" production matte box is fastened to the support rods on the bridge plate and can be swung forwards to facilitate lens changes.

See the information sheet „TECHN. INFORMATION 4"x4" Production Matte Box MB-16".

## 4"x4" Matte Box MB-17

The 4"x4" matte box is equipped with a rotatable filter stage for two push-through 4"x4" filters. The filter stage has at the rear a receptacle for 4 1/2" diameter filters and a reflex protection ring. French flags can be firmly secured with the enclosed holder.

See the information sheet „TECHN. INFORMATION 4"x4" Matte Box MB-17".

## Light-Weight Matte Boxes LMB-2 and LMB-3

The light-weight matte boxes are fastened directly to the front diameter of the lens. For the LMB-2 two 3"x3" filters, and for the LMB-3 two 4"x4" filters can be pushed into the filter stage. On prime lenses a „Series 9" filter in an 80mm adapter ring can be used additionally.

See the information sheets „TECHN. INFORMATION Light-weight Matte Box LMB-2" and „TECHN. INFORMATION Light-Weight Matte Box LMB-3".

## Finder Extension FE-2

The finder extension used in combination with the levelling rod allows comfortable work with the tripod - the viewing height remains stable.

### Mounting

- Loosen the knurled ring [▶picture](#) on the viewfinder.
- Remove the eyepiece.
- Attach the finder extension to the viewfinder, magnification adjustment [▶picture](#) on the user side.
- Ensure that the pin locks into the groove on the viewfinder.
- Pull the knurled ring tight.
- Attach the eyepiece to the finder extension.
- Ensure that the pin locks into the groove on the finder extension.
- Pull the knurled ring tight.
- Readjust the image by turning 180° with the image compensator. See chapter 6.

The finder extension is equipped with an magnification adjustment 10x to 17x. This is activated by turning the lever.

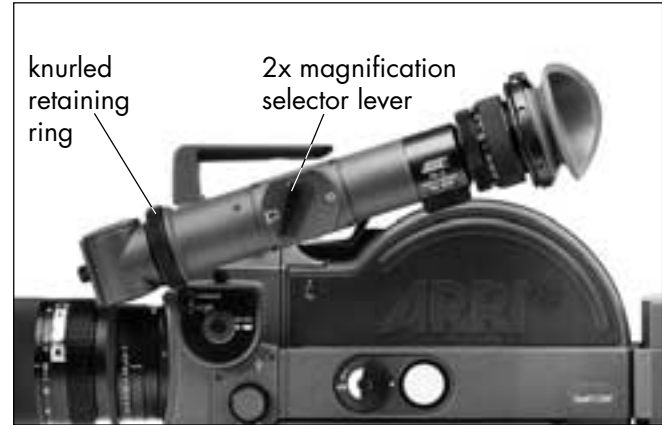

Two finder extensions can be used together. In this case the finder extension on the eye side must be set to 10x.



## Levelling Rod for Finder Extension EL-3

When filming from the tripod the levelling rod holds the finder extension constantly at eye level. The levelling rod for the finder extension can be used for the ARRIFLEX 535 and 535B as well as for the 16SR 3.

### Mounting

- Screw the lock bushing [▶picture](#) onto the tripod.
- Push the short mounting rod [▶picture](#) into the lock bushing and clamp - after mounting the levelling rod should stand vertical if possible.
- Fasten the levelling rod [▶picture](#) with the under clamp screw [▶picture](#) at the end of the mounting rod.
- Push the plug rail [▶picture](#) on the levelling rod into the holder on the finder extension.
- Fix the desired viewing height with the knurled screws [▶picture](#).

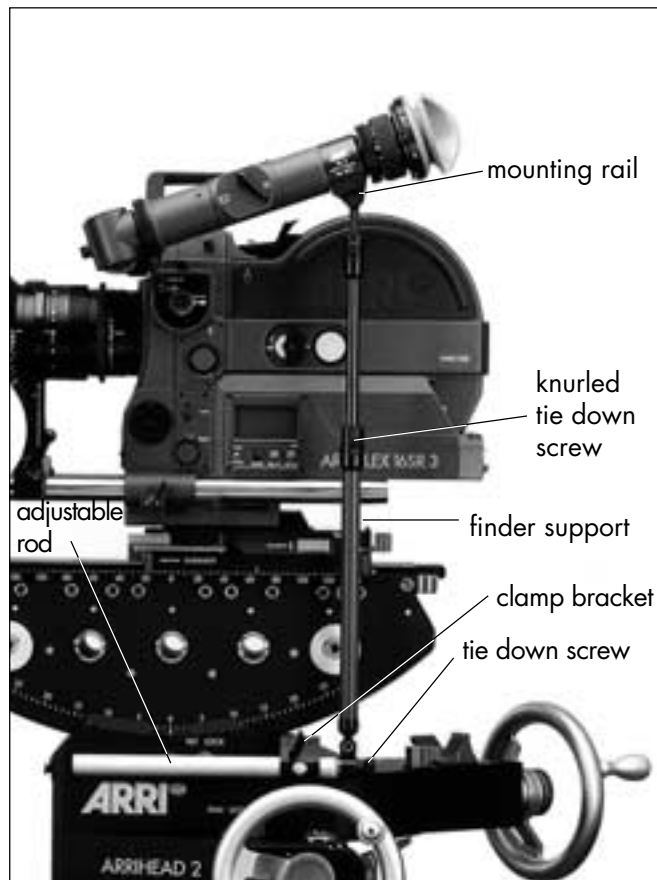

## Heated Eyecup HE-3 SR3 ✓

The heated eyecup prevents the eyepiece lens from misting up in the cold or in varying temperatures. The temperature of the in-built heater is kept constant by an electronic control.

The heated eyecup is supplied with an anatomically shaped eyecup and a folding eyecup.

### Mounting

- If appropriate remove the unheated eyecup.
- Snap the heated eyecup onto the eyepiece.
- Plug the angular plug on the power cable KC 27 into the camera socket [▶ picture](#) for the heated eyecup.
- Plug the power cable into the heated eyecup.
- Set the switch [▶ picture](#) to the desired temperature (LO=40°C, HI=55°C).

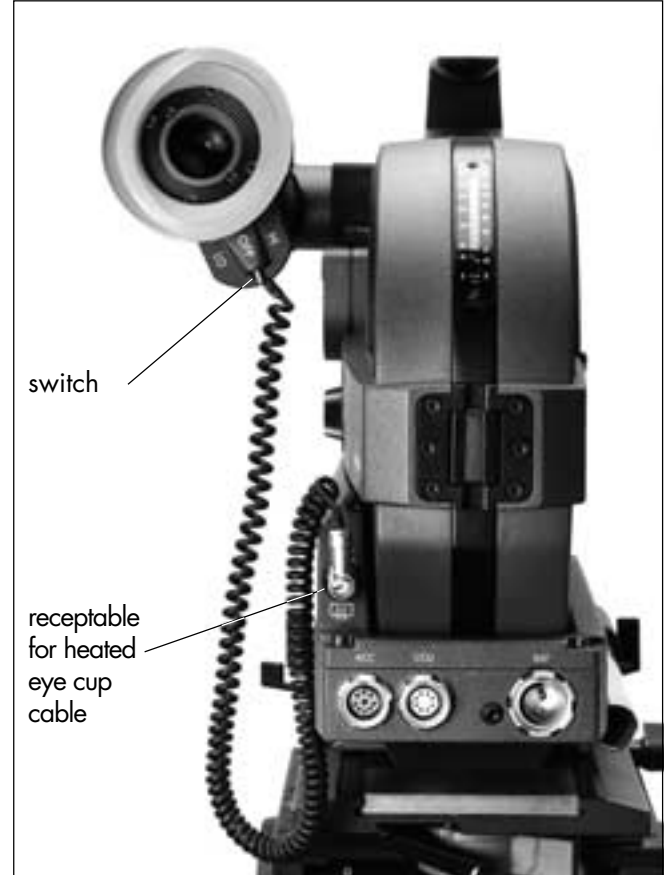

## 8. Adjustment Normal 16 /Super 16 SR 3✓

The centre of the image format is 1 mm different for the Super 16 (12.4 x 7.5 mm) than for Normal 16 (10.3 x 7.5 mm). In changing the image format, the lens mount and the viewfinder on the camera must be adjusted 1 mm to centre it. The opening of the Universal film gate is altered merely by addition or removal of a rail. For both formats different fibre optic viewing screens must be used.

Also on the bridge plate, the lightweight support and the video optic the adjustments for Normal 16 or Super 16 must be carried out.

### Adjusting on the Camera

#### Special Tool Kit

Included with camera

#### Altering the Lens Alignment



- Check Flange focal distance. See Chapter 13  
Standard: 52.000 – 0.010 mm  
HS: 51.970 – 0.010 mm

- Remove the 6 cylinder head screws [▶picture](#).
- Turn the lens mount 180°. The desired format (N16 or S16) must be top right.

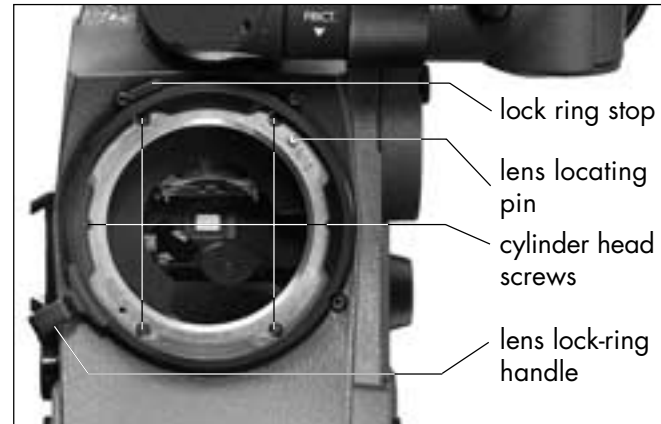

Ensure that the adjustment shims are not bent, dirtied or twisted during insertion.







- Mount the alignment screw  SW 1,5 (wrench width 1,5 mm) top right.
- Remove stop plate segment  and locking knob  after removing the fastening intermediate rings and refasten on the opposite side.
- Replace the 6 cylinder head screws and screw tight.
- Check viewing screen for focus.
- Check flange focal distance.

## Changing the Fibre Optic Viewing Screen

- For changing the fibre optic viewing screen see chapter 5.

## Adjusting the Opening in the Universal Film Gate

For Normal 16 part of the film gate is covered by a rail  which is removed when changing to Super 16.

- Unscrew the 6 screws  on the cover plate .
- Remove the cover plate .
- Unscrew the 8 cylinder head screws  on the film gate.
- Remove the film gate.



Ensure that the adjustment shims are not bent, dirtied or twisted during insertion.

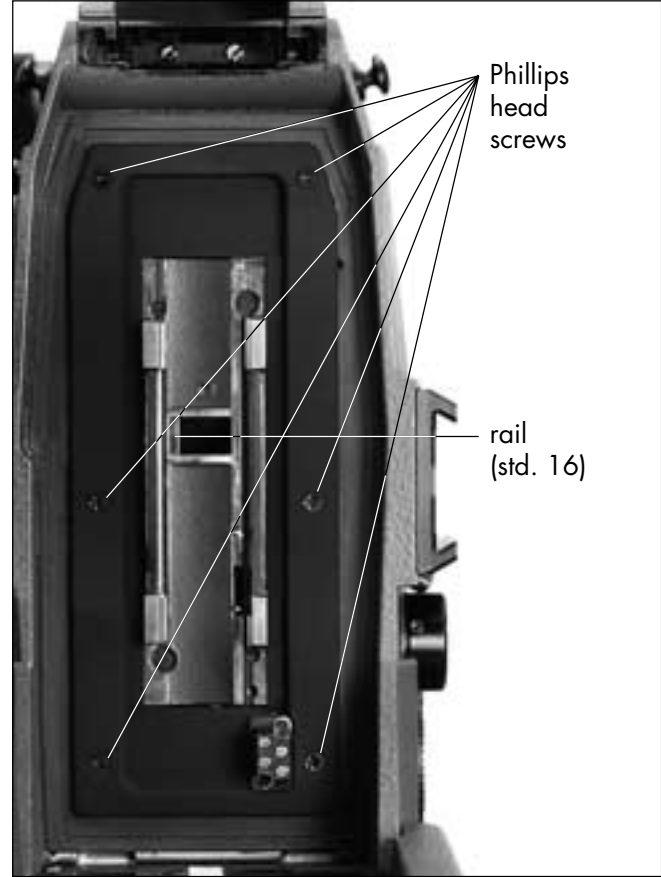

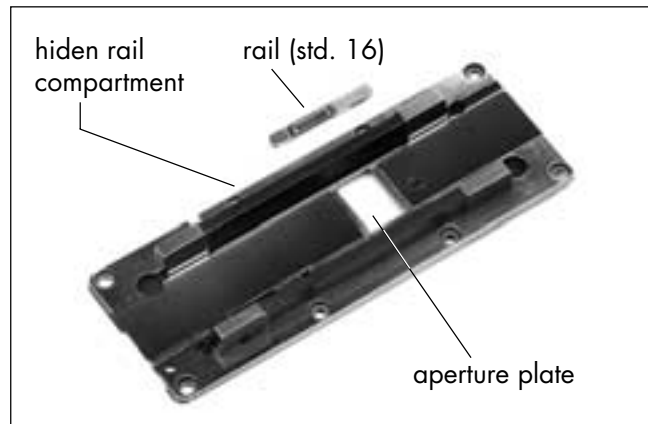
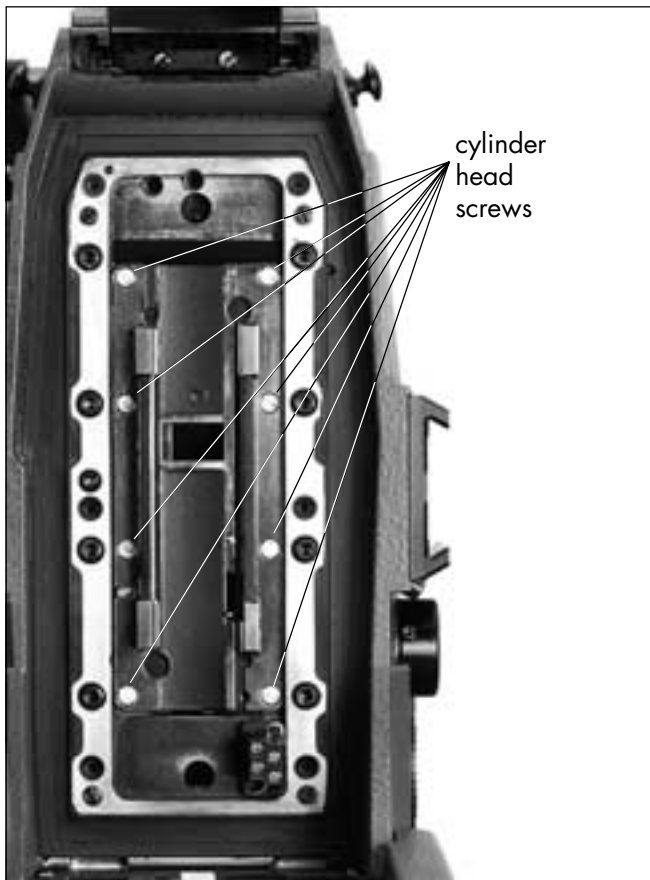

- When changing to Super 16 remove the rail from the film gate and place it in its case [▶ picture](#).
- When changing to Normal 16 remove the rail from its case and place it in position in the film gate [▶ picture](#).
- Remount the film gate in the reversed order.
- Check the tracking.

### Adjusting the Viewfinder Alignment



- Loosen the threaded bushing [▶picture](#) with special wrench A 16 SR-3 by approx. 2 full turns.
- Loosen the worm screw [▶picture](#) SW 2 by approx. 10 full turns.
- Remove the threaded bushing [▶picture](#).
- Hold the knurled ring [▶picture](#) firmly and completely unscrew the worm screw [▶picture](#).
- Untwist the knurled ring [▶picture](#) and remove the viewfinder.
- Unscrew the 4 cylinder head screws [▶picture](#).
- Turn the friction flange 180°. The desired format (N or S) must be legible.
- Replace the 4 cylinder head screws and screw tight.
- Clean the visible lens surfaces [▶picture](#) carefully with a moist optic cloth. If dirt clings, moisten the optic cloth with pure alcohol.
- Remount the viewfinder in the reversed order. Adjust the friction. See chapter 6.

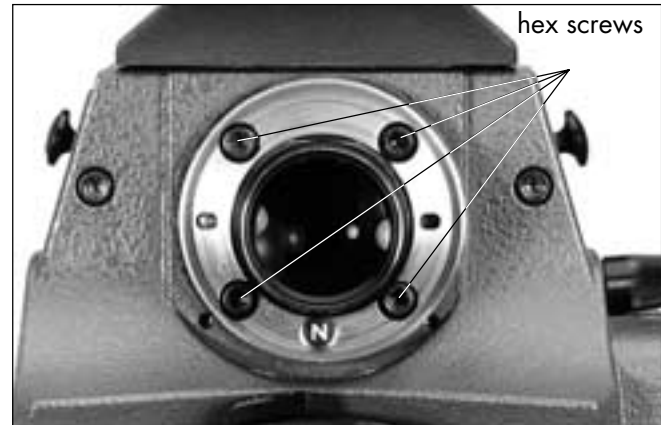
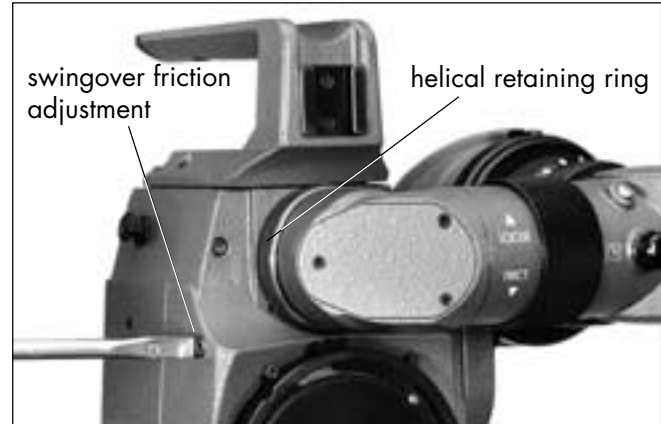

When replacing the viewfinder never forget the friction plate as otherwise the function of the optic will be impaired.



## Bridge Plates BP-6 and BP-7

- Unscrew the 3 screws  in the rail  in the upper part of the bridge plate.
- Turn the rail 180° and refasten. The marker must point to "Standard" for Normal 16 and to "SUPER 16" for Super 16.

Old bridge plates with 15mm support rods for 16SR must be equipped with Normal 16/Super16 capability prior to use. A conversion kit with instructions for modification is available.



## Lightweight Support

- Unscrew the guide screw [▶ picture](#).
- Turn the flange 180°. The red dot must be on "STANDARD" for Normal 16 and on "S16" for Super 16.
- Screw in the guide screw.

## Video Optic

- Unscrew the video camera from the C-mount.
- When changing from Normal 16 to Super 16 screw the red intermediate ring marked "S16" (delivered with the package) onto the C-mount thread on the video set firmly up to the collar.
- Rescrew the video camera.
- When changing back to Normal 16 remove the intermediate ring.
- Check the video optic adjustment and reset.

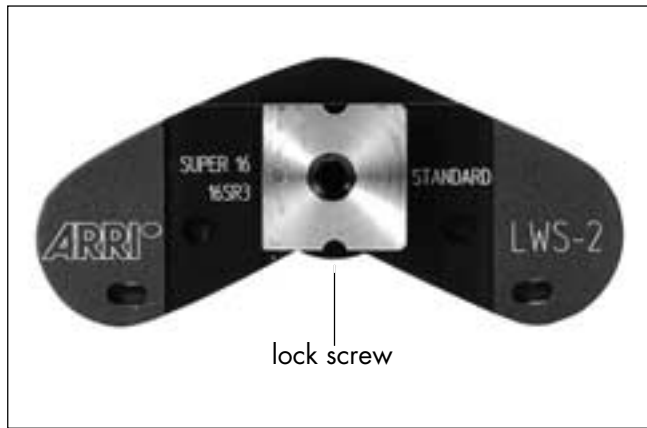



## 9. Display and Operating Elements

The camera electronics open up a variety of new possibilities: a comprehensive large LCD display advises quickly the chosen settings. The electronics control speed to exactly 1/1000 fps (to 100 fps). Even without an external synchronization unit synchronization is possible on a video monitor.



### Camera Display SR 3 ✓

The display advises which values have been set. The values in six various modes can be checked or changed.

The modes have the following meaning:

- 1 Standard (total exposed film or take counter/speed)
- 2 Programmable speed
- 3 Take or total exposed film counter/power supply
- 4 Time code time
- 5 Time code user bits
- 6 Time code sensitivity

### Choosing a Mode

After turning on the camera the display is in mode 1.

- Depress the MODE key until the desired mode appears. After mode 6 mode 1 appears again.

The display lights up. The light switches off approx. 30 sec after the last time the key has been depressed in order to reduce power use.

Indicators independent of the mode:

TC	TC-recording is turned on (see chapter 12).
TC flashes	Standby: since the last synchronization more than 8 hours have passed or the TC-generator has malfunctioned.  Run: as yet no recording has taken or is taking place (see chapter 12).
bat	Battery voltage < 20 V. The camera cannot be started.
asy	The camera is running asynchronously.
end	Indicator of the film end.

## Locking the SEL and SET Keys

The keys SEL and SET can be mechanically locked in order to avoid unintentional changing of the set values.

- Set the sliding switch  to LOCK - SEL and SET can no longer be activated.

The values can still be changed through the CCU-1.

## Setting the Speed

At the setting NORM on the sliding switch the standard speeds 24,00/25,00/29,97 and 30,00 fps are available. At the setting PS/CCU, any desired speed within the acceptable range of 5 to 75 fps at 1/1000 fps can be exactly set. On the HS camera (high speed) speeds from 5 to 99,999 fps at 1/1000 fps and speeds from 100 to 150 fps at 1/10 fps can be exactly set. Switching between standard and programmable speed is also possible while the camera is running.

## Camera Running

Camera run is started and stopped with the RUN key. The RUN function can also be activated by:

- the camera handgrip
- the shoulder set S-3
- remote control units RS-3 and RS-4
- the camera control unit CCU-1
- the external synchronization unit ESU-1
- the lens-control-system LCS

The LED for camera run shows if the camera is running synchronously (green) or asynchronously (red).

### Choosing Standard Speed

- Set the sliding switch to NORM.
- Switch the MODE key to mode 1 (standard).
- Switch through on the SEL key to the desired speed - the speed flashes approx. 3 sec. After 3 sec the previously set speed will reappear.
- While the light is blinking depress the SET key to set the speed.

### Choosing Programmable Speed in Advance

- Set the sliding switch to PS.
- Switch the MODE key to mode 2 (programmable speed).
- Enter the positions to be changed with the SEL key. Switch each chosen position with the SET key until the desired value is displayed. Enter the next position to be changed using the SEL key, or after the third position after the comma finish the setting. The third position after the comma (1/1000 fps) is in the upper line in the right-hand corner. On the HS camera the display switches to the speed indicator of 100 to 150 fps if the first digit of the speed indicator is switched above value 9. Speed can then only be set to 1/10 fps (neither 1/100 nor 1/1000 fps).

The last position (1/1000 fps) can also be changed while the camera is running in order to manually fine-tune camera frame speed (see synchronization on a video monitor).

### Changing the Programmable Speed while the Camera is Running

While the camera is running only the last position (1/1000 fps) of the programmable speed can be changed.

- Set the sliding switch to PS.
- The camera runs in RUN.
- Switch the MODE key to mode 2 (programmable speed).
- Decrease speed with the SEL key, increase speed with the SET key.

### Setting Speed from the Accessories

See chapter 10.

## Film Counter SR3✓

### Switching the Total Exposed Film/Take Counter

The film counter can only be switched from total exposed film to take counter while in Standby. The take counter is reset every time the camera is restarted. The total counter is reset by hand. To switch:

- Switch the MODE key to mode 3 (take or total exposed film counter/power supply).
- Depress the SEL key twice - the first position on the counter flashes.
- With the SET key it is possible to switch between „t“ take counter and total exposed film counter.

If the take counter is set the total counter will be shown in mode 1 (standard), and vice versa.

### Resetting the Total Exposed Film Counter

The total exposed film counter can only be reset while in Standby:

- Switch the MODE key to the mode in which the total exposed film counter is displayed (mode 1 or 3).
- Depress the SET key for approx. 3 sec - the counter resets.

### Switching from Meters to Feet

The film counter can only be switched between meters and feet while in Standby. To do this:

- Switch the MODE key to mode 3 (take or total exposed film counter/power supply). Press the SEL key once - „m“ or „ft“ flashes.
- Enter the desired unit of measurement with the SET key.

### Summary of Modes

On the following pages the modes are displayed in a table and examples for each mode are given.

Mode 1: Standard (Total Exposed Film or Take Counter/Speed)		
upper line	0007	Total exposed film (number) or take counter (t) in meters (m) or feet (ft).
lower line		See the table on the next page →
symbols		Only symbols independent of the mode.
example		<p>In mode 1 the total exposed film is shown. The set unit of measurement is meters. Since last resetting the total exposed film counter, 7m have been filmed. The sliding switch is at NORM. The set standard speed is 25 fps. There is no external synchronization unit, speed unit or remote unit plugged in.</p>

## Mode 1: Standard (Total Exposed Film or Take Counter/Speed) - lower line

	NORM PS/CCU	← Position of the sliding switch	
Standby	<ul style="list-style-type: none"> <li>• <i>25.00</i></li> <li>• <i>PS</i></li> <li>• • <i>ESU</i></li> <li>• • <i>SU</i></li> </ul>	<p>Set standard speed (24,00/25,00/29,97 or 30,00 fps). There is no external synchronization unit, speed unit or remote unit plugged in.</p> <p>Programmable speed. There is no external synchronization unit, speed unit or remote unit plugged in.</p> <p>External synchronization unit is plugged in. If no valid frame speed of 5 to 75 fps (5 to 150 fps on the HS camera) can be recognised, the fps symbol flashes.</p> <p>Speed unit or remote unit is plugged in and switched on.</p>	
Run	<ul style="list-style-type: none"> <li>• <i>25.00</i></li> <li>• <i>23.45</i></li> </ul>	<p>Set standard speed (24,00/25,00/29,97 or 30,00 fps).</p> <p>Programmable speed or speed set by external synchronization unit, speed unit or remote unit. At speeds of &lt; 100 fps the positions before the comma and two positions after the comma are displayed. At speeds of &gt; 100 fps (possible on the HS camera) the positions before the comma and one position after the comma are displayed.</p>	

Mode 2: Programmable Speed		
upper line	<p><i>PS 5</i></p> <p><i>ESU</i></p> <p><i>SU</i></p>	<p>Programmable speed. There is no external synchronization unit, speed unit or remote unit plugged in and switched on. At speeds of &lt; 100 fps the last position (1/1000 fps) is displayed.</p> <p>External synchronization unit is plugged in. The camera recognises whether a valid frame speed of 5 to 75 fps (5 to 150 fps on the HS camera) is set. If no valid frame speed can be recognised, the fps symbol flashes.</p> <p>Speed unit or remote unit is plugged in and switched on.</p>
lower line	<i>23.45</i>	<p>Programmable speed or speed set by the external synchronization unit, speed unit or remote unit. At speeds of &lt; 100 fps the positions before the comma and two positions after the comma are displayed. At speeds of &gt; 100 fps (possible on the HS camera) the positions before the comma and one position after the comma are displayed.</p>
example		<p>The sliding switch is at PS/CCU. The programmed speed is 23,455 fps. The third position after the comma for the speed setting (1/1000 fps) is displayed in the upper display line.</p> <p>There is no external synchronization unit, speed unit or remote unit plugged in.</p>

## Mode 3: Take or Total Exposed Film Counter/Power Supply

upper line	<i>t 03.2</i>	Take (t) or total exposed film counter (count) in meters (m) or feet (ft).
lower line	<i>U 25</i>	Power supply in [V].
symbols		Only symbols independent of the mode.
example		<p>In mode 3 the take counter is displayed. The set unit of measurement is meters. Since the start of the take 3,2m have been filmed.</p> <p>The power supply is 25V.</p>



Mode 4: Time Code Time		
upper line	17:20	h:min – hours and minutes.
lower line	31:25	sec:fps – seconds and positions before the comma of the TC-generator frame rate. See chapter 12.
symbols	<p>⌘</p> <p>⌘</p>	<p>Standby: TC-recording is switched on.</p> <p>Run: Time Code is being recorded. See chapter 12.</p>
example		<p>Actual time code time is 17:20:31 [hh:mm:ss]. The TC-generator frame rate is 25,000 fps.</p> <p>TC-recording is switched on. In Run time code will be recorded. See chapter 12.</p>

Mode 5: Time Code User Bits		
upper line	8A:65	Userbits 1-4.
lower line	35:F4	Userbits 5-8.
symbols	<p>TC UB UB</p> <p>TC UB UB</p>	<p>Standby: TC-recording is switched on. TC-recording is switched off.</p> <p>Run: Time code is being recorded. Time code is not being recorded. See chapter 12.</p>
example		<p>The user bits are 8A6535F4. User bits can contain the figures 0-9 and the letters A-F.</p> <p>TC-recording is switched on. In Run time code will be recorded. See chapter 12.</p>

Mode 6: Time Code Sensitivity		
upper line	25°	Temperature in the electronic housing (depress the SET key). To check the acceptable temperature range of -20°C - 50°C.
lower line	5 7	Timecode-sensitivity, TC-magazine is attached.
	5 -	No TC-magazine is attached.
symbols		Only symbols independent of the mode.
example		<p>The SET key is not depressed. The temperature in the electronic housing will not be displayed.</p> <p>A TC-capable magazine is attached to the camera. On the magazine the value 7 is set for the intensity of the TC-recording. See the table in chapter 12.</p>

## Exposure Control and ARRIGLOW

When using ARRIGLOW no exposure measurement is possible. To switch between exposure control and ARRIGLOW:

- Turn the adjustment knob  according to its markings to the stop position until it locks noticeably into place.

### Exposure Control

The exposure meter has an area of measurement of 13 to 31 DIN (16 to 1000 ASA) at speeds of 5 to 75 fps (5 to 150 fps on the HS camera). Speed is automatically taken into account by the exposure meter, regardless of whether the speed has been set internally (through the camera display) or externally (e.g. through the CCU-1 or the ESU-1), or whether the camera is in Standby or running.

In order to receive a correct reading it is necessary to set the correct film speed. To do this:

- Set film speed on the exposure meter with the rosette wheel .



If using polarizing filters use only circular ones, as the exposure meter will otherwise supply incorrect values.

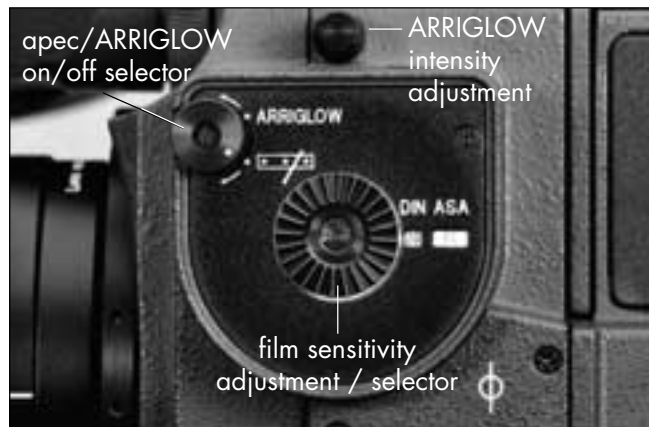

The exposure meter is set to an open sector of the mirror shutter of 180°. For lesser aperture stops exposure control must be corrected by resetting film speed. The correction for the aperture stop setting should be taken from the table on the next page. Intermediate values can be estimated (half a stop =  $-3 \text{ DIN} = \text{ASA}/2$ ).

Aperture Stop	DIN	ASA-Factor
180°	0	1
172,8°	0	1
144°	-1	0,8
135°	-1	0,8
90°	-3	0,5
45°	-6	0,25

The iris diaphragm is manually adjusted until the exposure field indicator needle is visible in the viewfinder, to the left, in the middle measurement field. The middle measurement field stands for correct exposure in a „normally bright“ scene, the outer points + and - show over- and underexposure of approximately two aperture stops.

**ARRIGLOW** SR 3✓

The illuminated frame viewfinder with variable brightness control - ARRIGLOW - facilitates filming in which due to the prevailing lighting conditions it would otherwise be difficult or impossible to see the format markings. It can be minutely adjusted to suit every lighting situation.

- Set the desired brightness with the adjustment wheel  picture.

If using effects filters such as strips of gauze on the back of the lens, or if the back of the lens is dirty, the entire viewfinder will be brighter.

ARRIGLOW and the exposure meter can only be used as alternatives to each other. Therefore it is recommended when using ARRIGLOW to proceed in the following manner:

- Switch to exposure meter.
- Set the aperture stop.
- Switch to ARRIGLOW.

## Checking the Mirror Shutter Setting

SR3✓

The mirror shutter setting can also be checked with the lens attached.

- In Standby depress the PHASE key and keep depressed - the angle symbol appears on the display. After approx. 2 seconds the set shutter angle will be displayed in the upper line.

## Synchronizing on the Video Monitor

SR3✓

With the new synchronization function the camera can be synchronized by hand on a monitor or a television. To film from a quartz-stabilized monitor, the frame speed and the phase of the camera must be aligned to the camera.

Through the external synchronization unit ESU-1 the camera can also automatically be synchronized on a video monitor (see the technical information sheet ESU-1).

## Fine-Tuning the Frame Speed

Frame speed can be finely tuned when the magazine is removed.

- In Standby, set the programmable speed to half the rated frequency on the monitor.
- Set the sliding switch to PS/CCU.
- Start the camera.
- Switch the MODE key on the display to mode 2 (programmable speed).
- If the camera is running change the speed with the SEL key (to decrease speed) and the SET key (to increase speed) until the bar on the monitor in the picture area no longer wanders.

## Shifting Phase

Shifting phase is effective only for the current take and should therefore be done again every time the camera is started.

- Start the camera.
- Hold the PHASE key depressed until the bar on the monitor has disappeared from the picture area.

## 10. Accessories

### Camera Control Unit CCU-1 SR 3✓

The camera control unit CCU-1 for the ARRIFLEX 535 and 535B can also be used on the 16SR 3. It enables manually controlled remote control of the following functions:

- Switching the camera on or off.
- Choosing the speed.
- Checking the set values.
- Displays and use of the film counter.
- Displays and setting TC-time (time code) and TC-user bits.
- Display of the set TC-sensitivity through the REMOTE-menu.

Setting TC-time and TC-user bits can only be carried out through the camera control unit or through external synchronization.

The camera control unit is supplied with power by the camera. If the camera is not plugged in the camera control unit will be fed by the internal batteries. As the battery unit limits the life of the camera control unit to approx. 5 hours, the display illumination switches off approx. 10 sec after last being touched when it is being

fed by batteries, and the camera control unit switches off after approx. 5 min.

### Replacing the Batteries

- Open the battery compartment  with a coin.
- Pull out the battery pack.
- Use batteries as designated on the battery pack.





- Insert the battery pack into the camera control unit and close the battery compartment.



Pay attention to the correct polarity of the battery pack!

### Plugging in the Camera Control Unit

- Plug the cable KC 24 (2,4m) or KC 30 (20m) into the socket  on the side of the camera control unit, pressing the slide on the plug in the direction of the plug.
- Plug the cable to the CCU-socket on the camera.
- Switch on the camera.
- Switch on the camera control unit with the red key  on the side.

### Key Functions in all Menus

RUN	switches the camera on or off.
SEND	sends the chosen values to the camera.
HELP	shows the help text for the activated menu. Cannot be used in the input mode. The help text can be left by pressing the ENTER key.
EXIT	ends input or leaves the activated menu.
LIGHT	switches display illumination on or off.



### Error Readings

In the case of functional errors on the camera the display on the camera control unit will show an error reading in the upper right-hand corner. The error reading remains visible until the error has been corrected. If the error is caused by the user, an error reading appears and disappears the next time a key is depressed. Simultaneously an acoustic signal is audible; this can however be turned off.



## The Main Menu

When the camera control unit is switched on the main menu appears on the display. This allows access to the sub-menus and shows the speed currently set on the camera. It also shows if the camera is switched off (OFFLINE), in Standby (STANDBY) or is running (RUN).

- Choose the desired menu with the keys 1, 3, 5, 6 or 8. The displayed menus SHUTTER (2), FORMAT (4) and PROGRAM (7) are for the ARRIFLEX 535 and have no function on the ARRIFLEX 16SR 3.

## The SPEED Menu

With the SPEED menu any desirable speed within the acceptable range of 5 to 75 fps at 1/1000 fps can be exactly set. On the HS camera speeds from 5 to 99,999 fps at 1/1000 ps and from 100 to 150 fps at 1/10 fps can be exactly set. Speed can be changed in Standby as well as when running. In both upper lines of the CCU the speeds currently set on the camera control unit and on the camera are displayed.

- Switch the sliding switch on the camera to PS/CCU.
- With keys 1 to 5, enter one of the listed standard speeds from the SPEED menu - the chosen speed is displayed in the uppermost line. The displayed speeds 6: -24 (backwards) and 7: -25 (backwards) are intended for the ARRIFLEX 535 and have no function on the ARRIFLEX 16SR 3.
- With the SEND key transfer the chosen value to the camera.

Alternatively any desirable speed within the acceptable range can be chosen:

- Switch the sliding switch on the camera to PS/CCU.
- Depress key 8 in the SPEED menu.
- Enter the desired speed, comma position with „.“.
- If not all positions after the comma were entered, finish the input with the ENTER key - the chosen speed is displayed in the uppermost line on the CCU.
- Transfer the chosen value to the camera with the SEND key.

All chosen speeds within the acceptable range of 5 to 75 fps (5 to 99,999 fps on the HS camera) can be increased or decreased in steps of 1/1000 fps in order to carry out a fine-tuning of the speed. For fine-tuning on the camera see chapter 9. To fine-tune on the camera control unit:

- Switch the sliding switch on the camera to PS/CCU.
- Pre-select the speed.
- In the SPEED menu depress key 9.
- Switch the camera to mode 2.
- Carry out fine-tuning: increase speed with key F1, decrease speed with key F2.
- Leave fine-tuning with the EXIT key.

### The REMOTE Menu

In the REMOTE menu the camera control unit displays the same information as the camera display. The keys F1 to F3 take on the meaning of the operating elements on the camera:

- F1 PHASE key
- F2 MODE key
- F3 SET key (RESET on the CCU)

In the lower line on the display the key functions are shown. For the ARRIFLEX 16SR 3 only the displays for keys F1, F2 and F3 are valid.

Operation of the camera in the REMOTE menu is carried out parallel to operation with the corresponding keys on the camera. See chapter 9.

### The TIMECODE Menu

In the TIMECODE menu the current values and the most recently set values on the camera control unit for time code and all user bits are displayed and can be reset. To change TC-time:

- Depress key 1 - „TIMECODE“ is displayed against a dark background.
- Depress the ENTER key - ready for input of the new TC-time.
- Enter all 6 positions of TC-time within the acceptable range of 00:00:00 to 23:59:59 - the new TC-time is displayed. If input is finished with the ENTER key, the unfilled positions will be filled with zeros.
- Depress the SEND key - the new TC-time is transmitted to the camera.

To change the TC-user bits:

- Depress key 2 - „USERBITS“ is displayed against a dark background.
- Depress the ENTER key - ready for input of the new user bits.
- Enter all 8 user bits with figures 0-9 or letters A-F - the new user bits are displayed. If input is finished with the ENTER key, the unfilled positions will be filled with zeros.
- Depress the SEND key - the new user bits are transmitted to the camera.

### The OPTIONS Menu

The OPTIONS menu allows access to the LENGTH UNIT and the COUNTER DISPLAY MODE.

The displayed points ASYNC-MODE and END WARNING are intended for the ARRIFLEX 535 and have no function on the ARRIFLEX 16SR 3.

- Choose the desired point with key 2 or 4.

### LENGTH-UNIT

Enables switching the film counter from meters to feet.

- Choose meters with key 1 or feet with key 2 - the desired unit of measurement is displayed against a dark background.
- Depress the SEND key - the desired unit of measurement is transmitted to the camera.

### COUNTER DISPLAY MODE

Enables switching the film counter between the total exposed film and the take counter. To switch on the camera, see chapter 9. To switch on the camera control unit:

- Choose the total exposed film counter with key 1 or take counter with key 2 - the chosen counter is displayed against a dark background. Menu point 3 (remaining film display) has no function on the ARRIFLEX 16SR 3.
- Depress the SEND key - the desired counter is transmitted to the camera and displayed in mode 1. If the take counter has been chosen, the total exposed film is displayed in mode 3, and vice versa.

**INFO Menu**

Enables access to the menu points STATUS and COUNTER, and switching on and off the acoustic signal on the camera control unit.

- Choose the desired menu point with key 1 or 2.  
Switch on or off the acoustic signal with key 4.

**STATUS**

Displays the values currently activated on the camera.

**COUNTER**

Displays the total exposed film count and the take count, and camera power supply.

**SOUND CCU ON/OFF**

- With key 4 switch on or off the acoustic signal. When switching on, a control signal can be heard.

**External Synchronization Unit ESU-1**

The external synchronization unit ESU-1 can be used for the ARRIFLEX 16SR 3 as well as for the ARRIFLEX 535 and 535B. It allows the camera to be synchronized with external equipment. Through use of a BNC-socket it is possible to synchronize on an external standard video

signal (50/60 Hz) or through an inductive pickup on a computer or video monitor. Other sources can be synchronized through the AC-input. Speed is displayed on the camera display in mode 2. The external synchronization unit has a phase shifter and a pilotone generator. Synchronization is also stored when the camera is switched off.

See TECHN. INFORMATION „External Synchronization Unit ESU-1“.

**Remote ON/OFF Switches RS-3 and RS-4**

The remote on/off switch can be clamped to the pan handle on the tripod and allows the camera operator to switch the camera on and off comfortably from his working position.

**SR3** ✓ The remote on/off switch RS-4 has an additional LED for camera run. Like the LED on the camera, it shows whether the camera is running synchronously (green) or asynchronously (red).

- Clamp the remote on/off switch to the pan handle and plug the cable into one of the RS-sockets on the right side of the camera.

## 11. Video-Assist-System

**SR3** ✓ The video-assist-system delivers a high-quality, nearly flickerfree monitor image for PAL or NTSC. The video-assist-system consists of the video set, the 1/2" color video camera CCD 2-FR and the anti-flicker processor AFP-2. The video set consists of the video carrying handle and the video optic together. These transmit the image from the beamsplitter to the video camera. The video set is supplied already mounted.



With the corresponding video optic the video-assist-system can also be used on the ARRIFLEX 535B and the 35 III.

The brightness of the video image is automatically adapted to the lighting conditions. This balancing can also be carried out manually. The white balance is designed for standard values for interior and outside filming. **SR3** ✓ The technology for image-storing used in this system enables reproduction of a stored image or the alternation between the real and the stored image - e.g. to align the camera to an earlier scene or for stop trick filming.

When using several video cameras the video-assist-system can also be synchronized by an external video signal.

The change-over from the color to the black/white CCD-camera is simple and requires no subsequent adjustment. The following beamsplitters are available:

- 20% BW-video 80% viewfinder
- 50% color video 50% viewfinder

When using these without the video-assist-system a 100% beamsplitter is used.

The video optic can be adjusted from Normal 16 to Super 16. The monitor displays the format filling the monitor surface width-wise (letterbox format on Super 16).



Neither the video camera nor the video optic should ever be used as a carrying handle, nor should heavy pressure in any other form be placed on it, as this could destroy it! The accessory shoe on the video camera is for mounting on the ARRIFLEX 35 III and should not be used when mounting on the ARRIFLEX 16SR 3.

For changing format from Normal 16 to Super 16 an intermediate ring must be used on/removed from the video camera. See chapter 8.

## Mounting the Video-Assist-System

SR 3✓

### Changing the Beamsplitter

The beamsplitter is under the carrying handle.

- Loosen the 4 screws [▶picture](#) on the carrying handle and remove the carrying handle.

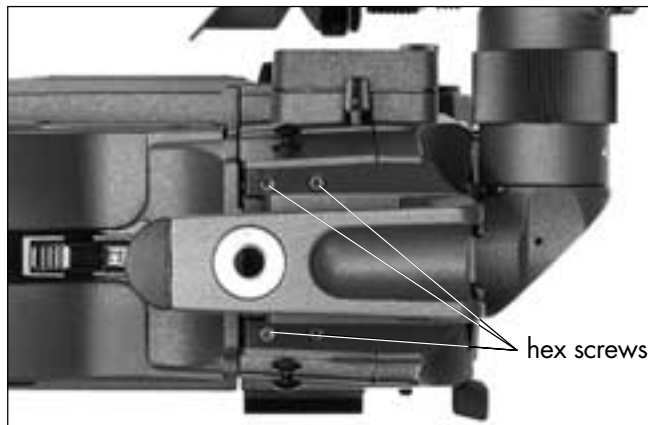
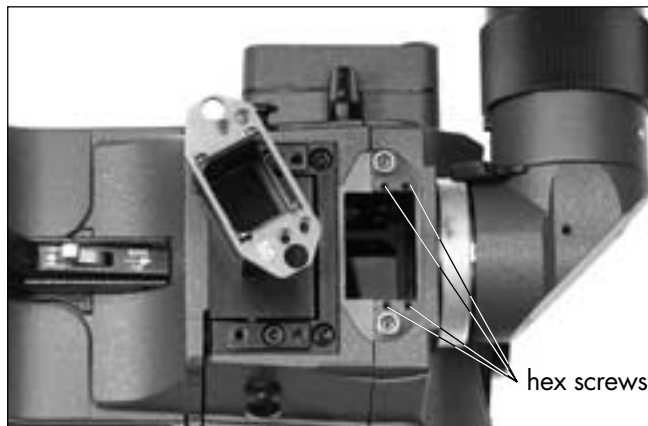

- Unscrew the 4 screws [▶picture](#) SW 1,5 (key width 1,5 mm) on the beamsplitter.
- Remove the beamsplitter at the bevelled edges (under the markings).
- Insert the desired beamsplitter and screw on with the 4 screws [▶picture](#).

### Mounting the Video Optic

- Attach the video handle without the video optic.
- Screw on with 4 screws, ensuring that the adjustment sockets for the beamsplitter and the carrying handle engage together.
- Attach the video optic to the video carrying handle.
- Screw tight with the knurled knob [▶picture](#).
- Pull tight the clamp ring [▶picture](#).
- Screw the video camera onto the C-mount thread on the video optic.
- Loosen the clamp ring [▶picture](#) approx. 15° (as seen in the direction of shooting, counter-clockwise).
- Turn the CCD-camera into the correct angle position (the marking on the back of the camera must stand upright).
- Pull tight the clamp ring.
- Screw the handles [▶picture](#) on the clamp ring into the desired position SW 1,5.

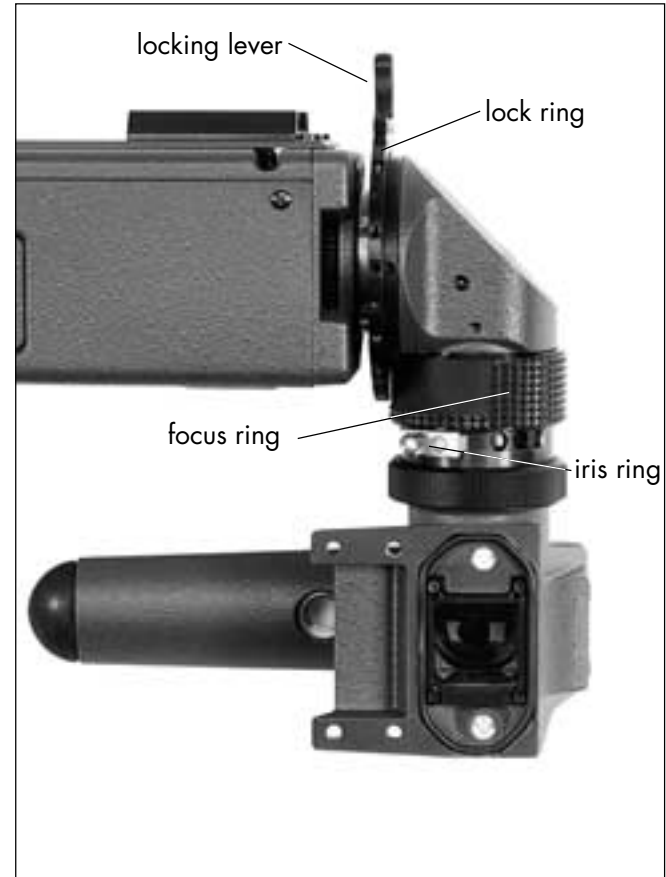

Note: If the video carrying handle remains on the camera when dismantling, the opening on the carrying handle should be closed over with the supplied protective cover.

### Wiring the Video-Assist-System

- Plug the anti flicker processor AFP-2 through the socket MOVIE CAMERA with cable KC 37 into one of the RS-sockets on the camera.
- Plug cable KC 34 into the socket VIDEO CAMERA on the anti flicker processor AFP-2 and into the video camera.

The video signal for the monitor is possible on two sockets on the anti flicker processor AFP-2:

Minimonitor:                      socket MINI MONITOR  
Standard video monitor:      BNC-socket VIDEO OUT





The BNC-socket „VD“ on the video camera CCD 2-FR is used for synchronization with an external video signal. Do not use as a video output!



- Set the code switch on the underside of the anti flicker processor to „A“.
- Adjust focussing and image position on the video camera. See below.

## Adjusting the Video Optic SR3✓

### Adjusting the Image Position

- Loosen the clamp ring  approx. 15° (as seen in the direction of shooting, counter-clockwise).
- Adjust the angle position by turning the CCD-camera, at the same time checking the image on the monitor.
- Set the width position with the adjustment screw  SW 1,3, taking care that on loosening the adjustment screw the image follows, otherwise press the CCD- camera at the screw-on position slightly upwards.
- Retighten the clamp ring.

### Adjusting Focus

- Loosen the aperture clamp with the aperture adjustment knob ; this also unlocks the focussing adjustment ring .
- Completely open the aperture.
- Set focus through the monitor with the focussing adjustment ring.
- Set the aperture to the monitor.
- Pull tight the aperture clamp.



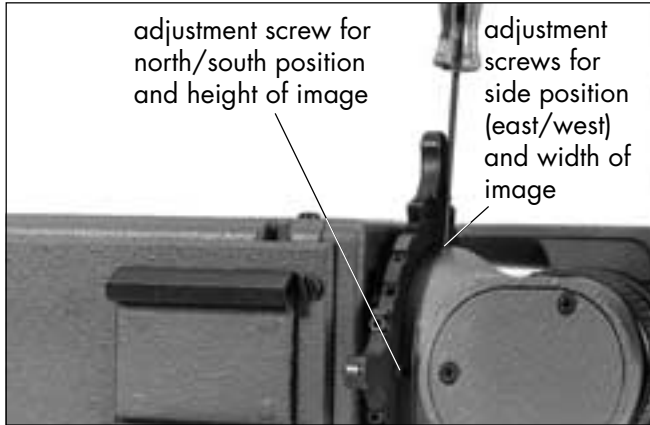

**Note:**

The focussing area of the video optic can be shifted by the gear  on the video camera.

Positions on delivery (looking at the left side of the camera):

Normal 16: Focus is almost at the stop position turning clockwise.

Super 16: Focus is almost at the stop position turning counter-clockwise.

## 12. Time Code SR 3✓

In modern electronic post-production time code is often used today. Quartz-synchronized film, sound and video recordings have been made possible through the use of equipment with TC-capability.

The ARRIFLEX 16SR 3 is equipped with a TC generator which produces 80bit time code corresponding to SMPTE RP136, Format Type C. The TC generator can be set using the CCU or a master clock. The precision of the TC generator ensures that for 8 hours after the synchronization (at 0°C - 50°C) the difference remains less than one frame. Every frame is therefore clearly identifiable for synchronization or editing lists. After 8 hours a further synchronization process should be carried out.

With the TC-Output the ARRIFLEX 16SR 3 can also take on the master clock function in a TC system.

TC recording is still active when the camera is synchronized using the external synchronization unit ESU on a video monitor. The maximum difference between the frame rate of the external synchronization and the TC frame rate is 1%.

Time code is recorded in the magazine corresponding to SMPTE RP114 at standard speeds 24,00/25,00/29,97/30,00 fps and at 23,976 fps.

The TC information also includes speed of recording which is described in connection with time code as frame rate. For the ARRIFLEX 16SR 3 the valid frame rate is always the most recently set standard speed.

### **TC-Indication on the Display**

The TC symbol has the following meaning:

The TC-Symbol has the following meaning:			
	TC-Symbol off	TC-Symbol blinks	TC-Symbol on
Standby	TC-recording is turned off.	Since the last setting of time code or since the last synchronisation more than 8 hours have passed.	TC-recording is turned on, no VSU is plugged in, time code is set or externally synchronized, the camera is set to a TC-compatible speed and the TC generator is ready.
Run	TC-recording is turned off, the magazine is not TC-capable or TC-sensitivity 0 is set.	There will be no TC-recording. Possible causes: <ul style="list-style-type: none"> <li>- the camera is running asynchronous</li> <li>- magazine is not TC capable</li> <li>- the recording module is defective</li> <li>- communication with the magazine could not be established.</li> </ul>	Time code will be recorded.

## TC-Input

The TC generator integrated in the ARRIFLEX 16SR 3 can be synchronized onto other equipment with TC generator. An LTC signal (Longitudinal Time Code) from any TC generator is plugged into the ACC socket. The signal level must be higher than  $500 \text{ mV}_{pp}$ . The camera automatically takes on TC time and TC user bits. If the LTC signal is correctly transferred the TC recording will be automatically switched on.

- Using the MODE key switch to Mode 4 (time code time)
- Plug the cable with the TC signal into the ACC socket. The last two entries on the indicator show a blinking „ec“ (external code). If the LTC signal is correctly transferred the indication „cc“ (correct code) appears for approx. 10 second before the indicator on the generator frame rate switches back.

## TC-Output

TC information is constantly available as 80bit LTC on the CCU socket and in Standby also on the ACC socket. Both outputs 5 V asymmetrical.

Through the TC-output TC-compatible equipment can be synchronized on the set once (for 8 hours) on the camera's time code or constantly supplied with time code by the camera. The camera then takes on the master clock function.

## Time Code and ESU-1

Also when using the external synchronization unit ESU-1 for synchronizing the camera to other equipment, time code can be recorded. Before attaching the external synchronization unit the TC generator the frame rate must be set to the expected frame rate. The maximum difference between the external synchronization and the TC frame rate is 1%. If this difference increases the TC recording switches off and the TC signal goes off. On reaching a valid speed range the TC recording switches on again and the TC signal appears again on the display.

## Using Time Code

### Turning on and off the TC Recording

- Using the MODE key switch to Mode 4 (time code time).
- Depress the SET key for approx. 3 sec. until the TC symbol appears or disappears on the display.

Time code starts when first turned on at time 00:00:00:00 and with the user bits 00000000. TC time and user bits can be set on the CCU-1 independently of each other. See chapter 10.

If a speed is set on the camera which does not correspond to TC, the TC generator retains the most recently set frame rate. While time code is in use and the speed is changed from one to another valid time code speed, the TC symbol on the display goes off for approx. 1 sec. and reappears once the TC generator is ready.

While the TC recording is switched on, turning off camera function is delayed by approx. 21 frames.

## Indicating Time Code or User Bits

- Using the MODE key switch to Mode 4 (time code time) or Mode 5 (time code user bits).

The time code time indicator will indicate hours:minutes in the upper line and seconds:frame rate in the lower line. In the case of frame rate, only positions before the comma will be shown:

24 24,000 fps  
25 25,000 fps  
29 29,970 fps  
30 30,000 fps  
23 23,976 fps

At speeds 29,970 fps and 23,976 fps the frame rate in the „Nondrop-Frame“ mode counts in accordance with SMPTE RP136-1990, 5.2.1, to correspond to NTSC video with 59,940 Hz. The „Nondrop-Frame“ mode results in a time difference to real time of exactly 0,1%.

## Setting TC Sensitivity

The intensity of the TC recording must be adjusted to the sensitivity of the film material. The knob for setting the TCS level (time code sensitivity) is on the take-up side on the magazine. The knob can be turned by hand if the magazine cover is open or with a small screwdriver if the magazine cover is closed.

„0“ means no recording, „1“-„9“ stand for the various intensity levels. The higher the TCS level, the higher the intensity of the recording. The difference in intensity of the successive TCS levels corresponds to one aperture stop. The set level can also be seen in Mode 6 on the display.

The TCS levels of the most frequently used film types:

Description	Type	TCS
<b>Kodak Eastman</b>		
7222	BW-negative	8
7231	BW-negative	9
7239	Colour reversal	5
7240	Colour reversal	6
7245	Colour negative	6
7248	Colour negative	6
7250	Colour negative	5
7251	Colour negative	4
7292	Colour negative	5
7293	Colour negative	5
7296	Colour negative	5
7297	Colour negative	6

Description	Type	TCS
<b>Agfa Gevaert</b>		
PAN 250	BW-negative	9
XT 100	Colour negative	5
XT 125	Colour negative	6
XT 320	Colour negative	5
XTS 400	Colour negative	4
<b>Fuji</b>		
8427	Colour reversal	6
8428	Colour reversal	6
8610	Colour negative	7
8620	Colour negative	6
8630	Colour negative	6
8650	Colour negative	5
8670	Colour negative	5

## TC Buffer

The ARRIFLEX 16SR 3 ensures not only high accuracy of the time code but also allows the TC clock to continue running while the camera is switched off as long as the camera is connected to a power supply. The TC generator needs a power supply of 10mA if the camera is switched off.

For changing the battery a short-term buffer of one minute is provided. In order for this buffer to function however it is necessary that the camera be connected to a power supply for at least 10 min. prior to this. If the buffer is exceeded, the TC time is lost and the TC symbol no longer appears when the camera is turned on again. Therefore a loaded battery should be kept ready before the battery change.

To enable the camera to be used while mobile without losing TC time, the use of an on-board battery is recommended. An on-board battery can receive the TC buffer for more than 100 hours. To reduce power consumption while working with the battery, the battery should be removed during lengthy breaks in filming (longer than a day). Before recommencing filming TC synchronization must be carried out again.

## Testing the TC Recording

It is not possible to test the TC recording with an attached on-board battery. Therefore the camera must be powered through a cable.

- Set a TC-compatible speed on the camera.
- Turn on the TC recording (see above).
- Set the magazine without film with the cover on the take-up side on the camera completely open.
- Set to TCS level 9 and check in Mode 6 (see above).
- Start the camera function - the TC symbol blinks. After approx. 1 sec. the TC symbol must remain constant.
- Hold a narrow white strip of paper a few mm in the film exit - at the outer end of the film guide a small red dot must be visible.



## 13. Maintenance

### Replacing the Magazine Drive Gear

Damaged magazine drive gears must be replaced as they cause noise.

- Open the magazine on the take-up side.
- Unscrew the 3 screws on the magazine gear.
- Replace the gear.
- Ensure that the gear has been replaced with the arrows visible.
- Screw in firmly the gear.

### Cleaning the Magazine Throat Assembly

The magazine throat assembly should be dismantled and cleaned if

- it has become very dirty through bad film material, or
- the film runs through the magazine throat with difficulty.

#### Dismounting

- Loosen the 2 screws . The screws are very tight!

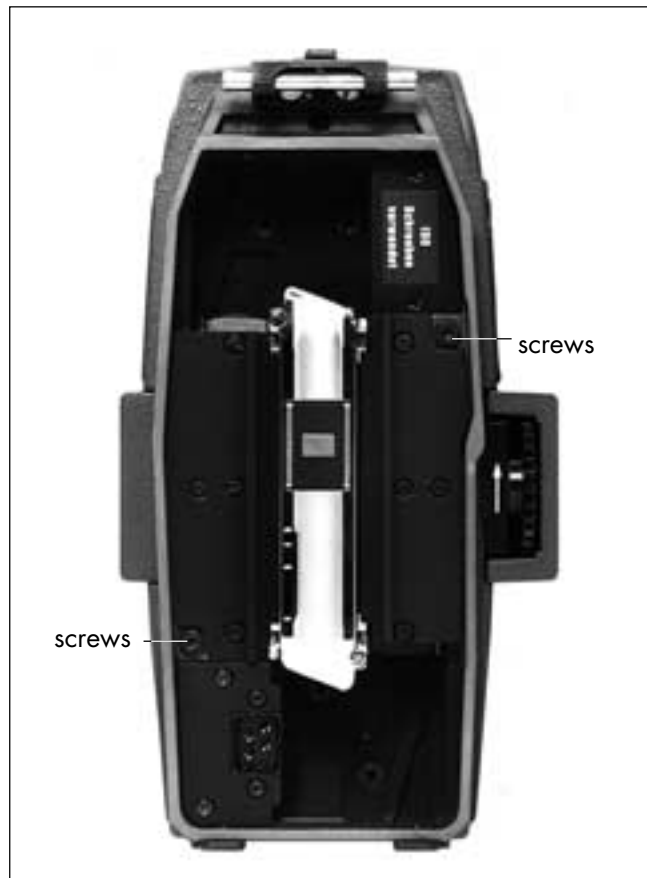



magazine with magazine throat removed



magazine throat

- Remove the magazine throat assembly . The gear drum and film channel will become visible.
- Possibly emulsion or film scraps are in the interior. Clean carefully.



Under no circumstances blow substances away!

Remove deposits from the film with The ARRI plastic film track cleaning rod or with a paper towel and some spirits.



Under no circumstances remove deposit from the film with metal tools!

### Mounting

- Replace the magazine throat assembly. Only one mounting orientation is possible: pay attention to the form. Push the assembly to lock in.
- Replace the screws. Tighten the first screw completely before screwing in the second screw.

The torque of the screws has no influence on the image sharpness or adjustment of the film channel.

### Replacing the Lens in the TC-Magazine Recording Unit

Strong scratches on the lens of the recording unit cause the light to scatter. The lens on the recording unit should be replaced by the ARRI Camera Service department.

### Replacing the Glass Window

Large scratches on the gate for the film end sensor on 16SR 3 magazines could prevent the film end sensor from functioning. The glass window should be replaced.

- Replace the frame with the glass window.
- Check function.

### Flange Focal Distance

The flange focal distance should be checked after every change from Normal 16 to Super 16, or when optimal sharpness could not be attained during the sharpness test. When using the compensation adapter for the 41 mm bayonet, the depth gauge A 16 SR-18 for the ARRIFLEX 16 SR II can be used. The measurement for the PL-mount is however more accurate.

## Necessary Special Tools

Depth gauge for PL-mount

or

Depth gauge                    A 16 SR-18

Depth gauge cylinder    A 16 SR-19

Depth gauge base        A 16 SR-20

Depth gauge plate        A 16 SR-21

## Checking the Flange Focal Distance

- Adjust the depth gauge with the gauge cylinder on the gauge base to „0“.
- Turn the mirror shutter downwards with the inching knob.
- Lay the gauge plate on the film gate and check the flange focal distance  with the gauge.
- Standard camera:        52,000 mm -0,010 mm
- HS camera:                51,970 mm -0,010 mm

## Adjusting the Flange Focal Distance

The flange focal distance can be set with the adjustment shims which sit between the camera housing and the PL-mount.

- Check the flange focal distance (see above).
- If appropriate remove the compensation adapter.
- Unscrew the 6 cylinder head screws.
- Remove the PL-mount.

- Exchange the adjustment shims, ensuring that they do not get bent, dirtied or twisted in the process.
- Replace the PL-mount, ensuring that the marking for the chosen format is in the upper right-hand corner.
- Screw in the 6 cylinder head screws.



Pull the 6 cylinder head screws tight before checking the flange focal distance as otherwise a false reading will be attained.

- Check the flange focal distance (see above).





## Setting Friction on the Viewfinder

When friction decreases it is necessary to readjust it.



### Necessary Special Tools

Special key A 16 SR-3

Allen key A 16 SR-16

Allen key A 16 SR-17

### Friction Left-Right-Swing (190°)

- Loosen the threaded socket  with the special key A 16 SR-3 approx. 2 revolutions.
- Tighten the endless screw  with the Allen key A 16 SR-16 until the desired friction is reached.
- Retighten the threaded socket.



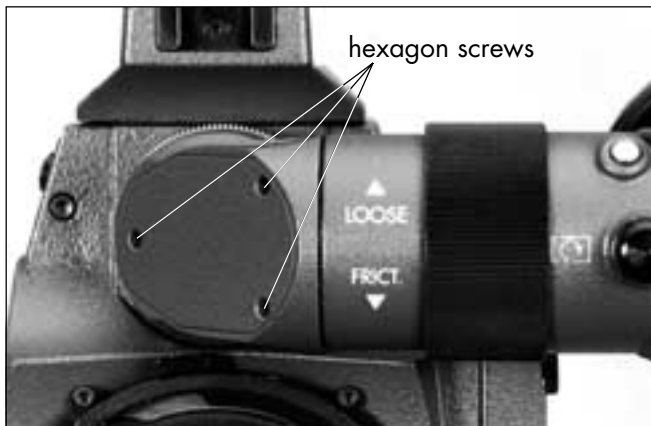

### Friction on Viewfinder Arm (25°)

- Loosen or tighten the 3 inner hexagon screws [▶picture](#) evenly one after the other with the Allen key A 16 SR-17 until the desired friction is reached.

## Replacing the Electronic Housing

SR3✓

If the electronics break down the entire electronic housing is to be exchanged. The electronic housing on the standard camera is not the same as that on the HS camera and should not be interchanged with it.

- Place the camera without the magazine upside down on a soft surface.
- Unscrew the 6 screws  SW 2 (key width 2 mm) in the bottom of the camera.
- Turn the camera around again.
- Pull up the camera shaft.
- Replace the electronic housing.
- Remount the camera, taking care that the intermediate metal plate is placed on the new electronic housing before mounting.

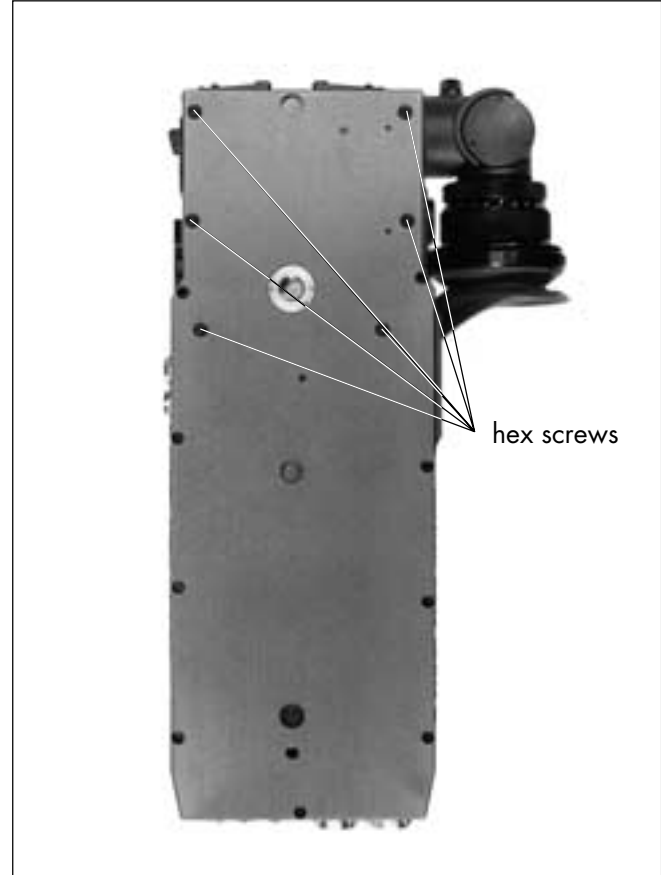





## Camera-Checks

Checking Camera Readiness	
<b>Wiring</b>	Check complete wiring and the position of the plug.
<b>Electronics</b>	Switch through all modes and check the set values.
<b>Time Code</b>	Set TC and check TC-sensitivity on all magazines.
<b>Batteries</b>	Check power supply to all batteries in display mode 3 (take counter/power supply): $U > 20 \text{ V}$ .
<b>Exposure Meter</b>	Check set film speed.
<b>Fiber Optic Screen</b>	Check if the desired fiber optic screen is in place. Check the cleanliness of the fiber optic screen with the ARRIGLOW.
<b>Fluff Check</b>	Remove the lens and magazine. Turn the mirror shutter forwards with the inching knob and check the film gate for fluff on both sides.
<b>Film Track</b>	Carefully examine the film track and film gate for deposit or scratches.
<b>Optics</b>	Check the cleanliness of the optic surfaces of the lens and viewfinder.
<b>Film Running</b>	Let the camera run very slowly for a few seconds with the PHASE key. Check if the set shutter angle appears in the display. Let the camera run a little further. Check if the RUN-LED illuminates green.

<b>ARRIGLOW</b>	Let the camera run very slowly with the PHASE key. Watch the right shutter edge through the lens opening: the shutter must be completely closed before the ARRIGLOW light illuminates. Watch the left shutter edge: the light must have gone off before the shutter opens.
<b>Magazine</b>	The red markings on the casing must no longer be visible once the magazine has been attached to the camera.

<b>End of the Day Check</b>	
<b>Batteries</b>	Charge empty batteries and discharge and recharge partially empty batteries.
<b>Film Track</b>	Clean the film track with an optic brush and an optic cloth. Use no solvents.  Under no circumstances remove film deposit with metal tools; use only the ARRI plastic film track cleaning rod.
<b>Film End Sensor</b>	Check the lens on the camera body and the glass window of the film end sensor on the magazine for dirt
<b>Finder Friction</b>	Check finder friction, and if necessary readjust. See chapter 13.
<b>Magazine Gear</b>	Examine the magazine drive gear for damage. Smooth out slight deformations with the back of a knife. In the case of strong deformations replace the magazine gear. See chapter 13.
<b>Cleaning Magazines</b>	Clean the feed and take-up sides of empty magazines. Check if the film core and clamp core are in place. On TC-magazines clean the film end sensor window. Attach the loop protector to the magazines.

## Technical Data

### Image Format

Normal 16: 10,3 x 7,5 mm

Super 16: 12,4 x 7,5 mm

### Magazine

Coaxial quick-change magazine for 120m film in the following varieties:

- standard magazine
- standard magazine with TC-recording unit
- HS magazine
- HS magazine with TC-recording unit

### Lens Mounting Flange

54mm PL-mount

Lenses with 41 mm ARRI bayonet mount with a compensation adapter

### Flange Focal Distance

Standard: 52,000 - 0,010 mm

HS: 51,970 - 0,010 mm

### Mirror Shutter

Mechanically adjustable

Fixed settings for shutter angles of 45°, 90°, 135°, 144°, 172,8°, 180°

### Film Movement

Jointed pull-down film transport claw with registration pin

### Variable Speed

Standard: 5 ... 75 fps

HS camera: 5 ... 150 fps

### Noise Level

Standard: 20 dB(A) + 2 dB(A)

HS camera: 27 dB(A) +/- 2 dB(A)

### Exposure Control

Manual exposure control

13 ... 31 DIN

16 ... 1000 ASA

### ARRIGLOW

Illuminated frame viewfinder with continuously adjustable brightness

### Viewfinder

Adjustable three-dimensionally with automatic image steadiness compensation and additional manual image steadiness compensation, total magnification 10 x.

### Fiber Optic Screens

Interchangeable for various shooting formats

**Temperature Range**

-20° to +50°

**Power Supply**

24 V DC

Acceptable voltage range: 20 ... 32 V DC

**Operation and Display**

Standard speeds 24; 25; 29,97; 30 fps

Other speeds programmable

Standard: 5 ... 75 fps at 1/1000 fps exactly

HS camera: 5 ... 99,999 fps at 1/1000 fps exactly

100 ... 150 fps at 1/10 fps exactly

Total exposed film or take counter in meters or feet

**Function Monitoring**

Power supply

Synchronous running

TC-recording

Display of time code information

**Video-Assist-System**

for PAL or NTSC consisting of:

- video carrying handle

- video optic

- 1/2" color video camera CCD-2

- anti flicker processor AFP-2

**Beamsplitter**

Color: 50% video 50% viewfinder

SW: 20% video 80% viewfinder

without video: 100% viewfinder

**Time Code**

Intergrated TC-generator produces 80 bit time code

corresponding to SMPTE RP136, format, type C

Recording in the TC-magazine corresponding to SMPTE

RP114

Can be set through the camera control unit CCU or

through external synchronization

TC-output: LTC, 5 V asymmetrical

TC-input: LTC, 500 m Vpp ... 20 Vpp

**Dimensions**

Viewfinder horizontal: L x B x H: 267 (336) x 171 x 236

Viewfinder vertical: L x B x H: 267 (336) x 107 x 294

Length in [mm] (with on-board battery) measured from lens flange

**Weight**

approx. 7 kg

with magazine, 120m film and on-board battery

## Order Numbers

ARRIFLEX 16SR 3 .....	K1.45999.0
ARRIFLEX 16SR 3 HS .....	K1.45998.0

### Installation

ARRIHEAD 2 .....	K2.43670.0
Hydro-head ARRI 150 H .....	K2.50491.0
Hydro-head ARRI 150 M .....	K2.50463.0
Hydro-head ARRI 100 L .....	K2.50462.0
Bridge plate BP-6 .....	K2.42572.0
Support rods 240 mm for BP-6 .....	K2.43046.0
Bridge plate BP-7 .....	K2.41010.0
Conversion set S16 for BP-7 .....	K2.46947.0
Shoulder set S-3 .....	K2.41460.0
Camera handgrip .....	K2.45886.0
Shoulder pad .....	K2.21860.0

### Power Supply

Main fuse 10 A Picofuse .....	K2.45423.0
Accessory fuse 2,5 A Picofuse .....	K5.45422.0
On board battery NC 24/1,2 .....	K2.46550.0
Attachable adapter .....	K4.45285.0
Charger adapter cable KC 38 for NC 24/1,2 .....	K2.43196.0

Battery NC 24/7 R .....	K2.41950.0
Connector cable KC 20 .....	K2.41966.0
Connector cable KC 29 (spiral) .....	K2.44693.0
Charger NCL 24 R .....	K2.42010.0
Couple charger NCL 24/1,2 .....	K2.47014.0
Mains unit NG 12/24 R .....	K2.44481.0
DC/DC converter 24V/12V-22W .....	K2.46884.0

### Magazines

Magazine without TC .....	K2.45161.0
Magazine with TC .....	K2.45162.0
HS-magazine without TC .....	K2.45164.0
HS-magazine with TC .....	K2.45165.0
Film core .....	K4.15005.0
Clamp core .....	K4.15912.0

### Optics

Compensation adapter 41mm bayonet .....	K2.45955.0
---	------------

### Optical Accessories

Viewfinder extension FE-2 .....	K2.45296.0
Viewfinder levelling rod EL-3 .....	K2.42533.0
Heated eyecup HE-3 .....	K2.42202.0

Cable KC 27 .....	K4.44549.0
Light-weight support LWS-2 .....	K2.43539.0
Universal follow focus device FF-3 .....	K0.59979.0
Light-weight follow focus device .....	K2.21541.0
4"x4" production matte box MB-16 .....	K2.44472.0
4"x4" matte box MB-17 .....	K2.42100.0
3"x3" light-weight matte box LMB-2 .....	K0.59954.0
4"x4" light-weight matte box LMB-3 .....	K2.44471.0

### Accessories

Camera control unit CCU-1 .....	K2.42320.0
Power cable KC 24 (2,4 m) .....	K4.44003.0
Power cable KC 30 (20 m) .....	K2.43183.0

External synchronization unit ESU-1 .....	K2.46006.0
Remote ON/OFF switch RS-3 .....	K2.44478.0
Remote ON/OFF switch RS-4 .....	K2.46942.0

### Video

3" video-camera CCD 2-FR PAL .....	K2.45865.0
3" video-camera CCD 2-FR NTSC .....	K2.45866.0
Anti flicker processor AFP-2 PAL .....	K2.43194.0
Anti flicker processor AFP-2 NTSC .....	K2.43195.0
Cable KC 34 (replacement) .....	K4.45827.0
Cable KC 37 (replacement) .....	K4.42752.0

### Maintenance

Magazine drive gear .....	K5.15090.0	
Depth gauge	A 16 SR-18 .....	K4.26370.0
Depth gauge for 54mm PL-mount .....	K4.26637.0	
Gauge cylinder	A 16 SR-19 .....	K5.26270.0
Gauge base	A 16 SR-20 .....	K5.26277.0
Gauge plate	A 16 SR-21 .....	K4.26290.0
Special key	A 16 SR-3 .....	K5.26129.0
Allen key	A 16 SR-16 .....	K5.26152.0
Allen key	A 16 SR-17 .....	05.02824.0

Electronic housing .....	K4.42630.0
Electronic housing for HS-camera .....	K4.43334.0

### Adjustment Screws

Overview .....	K4.37092.0	
width [mm]	color/material	
0,0127	silver .....	K5.37098.0
0,0254	violet .....	K5.37099.0
0,0380	red .....	K5.37100.0
0,0640	white .....	K5.37101.0
0,1000	copper .....	K5.37102.0
0,1500	copper .....	K5.37103.0

# Index

1/2" color video camera CCD 2-FR .....	75
1.5mm support rods .....	9
41 mm ARRI bayonet .....	35
4"x4" matte box MB-17 .....	45
4"x4" production matte box MB-16 .....	45
54mm PL-mount .....	34

## A

AC-input, external synchronization unit .....	74
ACC-socket, time code .....	82
Accessories, optical .....	41
Acoustic signal, camera control unit .....	74
Adapter, attachable .....	14
Adjusting	
lens alignment .....	49
viewfinder alignment .....	52
Angenieux lenses .....	32
Anti flicker processor AFP-2 .....	75
ARRI bayonet for 41 mm mounting flange .....	35
ARRI MACRO lenses .....	33
ARRIGLOW .....	67
checking .....	97
ARRIHEAD 2 .....	7

Asynchronous running .....	56
Attaching	
compensation adapter .....	35
lens, 41 mm bayonet mount .....	35
lens, 54mm PL-mount .....	34
magazine to the camera .....	30
Automatic image steadiness .....	38
Automatic stop .....	26

## B

Balancing with the bridge plate .....	9
Batteries, camera control unit .....	69
Battery NC 24/7 R .....	14
Battery cable KC 20 .....	14
Bayonet	
41 mm mount .....	35
54 mm PL-mount .....	34
Beamsplitter, video optic .....	75
Bridge plate BP-6 .....	7
conversion Normal 16/Super 16 .....	53
Bridge plate BP-7 with 1.5mm support rods .....	9
conversion Normal 16/Super 16 .....	53



<b>C</b>	
Camera body .....	25
Camera control unit CCU-1 .....	69
attaching	
starting camera run	
Camera display .....	55
Camera handgrip .....	11
Camera run	
changing .....	57
starting and stopping .....	56
CCU-socket	
camera control unit .....	70
time code .....	82
Charger NCL 24 R .....	14
Charger adapter cable KC 38 .....	14
Checks	
ARRIGLOW .....	97
camera readiness .....	96
end of day .....	97
fiber optic screen .....	96
film running .....	96
fluff.....	96
magazines .....	97
mirror shutter setting .....	68
film transport claw engaging with film perforation.....	25
time code recording .....	86
Circular polarizing filter .....	66
Clamp core .....	18
Cleaning	
fiber optic screen .....	29
film end sensor .....	18
film track .....	31
magazine .....	18
magazine throat assembly .....	87
pressure plate and stone .....	24
time code magazine .....	18
Collapsible core holder .....	18
Color video camera CCD 2-FR .....	75
Compensation adapter .....	32
installing .....	35
removing .....	36
Connector cable KC 27 for heated eyecup .....	48
Conversion Normal 16/Super 16 .....	49
bridge plates .....	53
changing the Universal film gate sector .....	50
lens alignment .....	49
light-weight support .....	54
video optic .....	54
viewfinder alignment .....	52
Cooke lenses .....	32
Core holder .....	18
Cover plate in the Universal film gate .....	50

**D**

DC/DC converter 24V/12V-22W .....	15
Depth gauge .....	90
Depth gauge cylinder .....	90
Depth gauge plate .....	90
Dimensions .....	99
Diopter compensation .....	39
Display .....	55
camera, choosing the mode .....	55
illumination, camera .....	55
illumination, camera control unit .....	69
Double charger NCL 24/1,2 .....	14

**E**

Effects filters when using ARRIGLOW .....	67
Electronic housing, replacing .....	94
End of the Day Check .....	97
Error readings, Display on the camera control unit....	70
Exposure control .....	66
External synchronization unit ESU-1 .....	74
using with time code .....	83
Eyecup .....	39
folding .....	48
heated .....	48
Eyepiece .....	39

**F**

Feet/meters, switching between .....	
on the camera .....	58
on the camera control unit .....	73
Fiber optic screens .....	
changing .....	29
checking .....	96
overview .....	29
Film .....	
attaching to the clamp core .....	22
attaching to the core holder .....	22
threading, feed side .....	20
threading, take-up side .....	21
Film core .....	18
Film counter .....	58
Film end sensor .....	18
cleaning .....	18
Film head .....	19
Film loop, creating .....	21
Film roll, attaching .....	20
Film run, checking .....	96
Film speed .....	66
Film track .....	
checking .....	97
cleaning .....	31
Film transport claw .....	25

engaging with film perforation, checking .....	25
Filming from a video monitor .....	68
Filters .....	45
polaroid .....	66
Finder .....	38
extension FE-2 .....	46
Finder side .....	38
setting friction .....	92
Fine-tuning speed	
on the camera .....	57
on the camera control unit .....	72
Flange focal distance .....	98
adjusting .....	90
checking .....	90
Fluff check .....	26,96
Focus adjustment, video optic .....	78
Focus adjustment ring, video optic .....	78
Focus range, setting on the video optic .....	79
Focussing knob .....	43
Folding eyecup .....	48
Follow focus device	
light-weight .....	44
Universal .....	43
Frame finder, illuminated .....	67
Frame rate .....	80
Frame speed, fine-tuning when synchr. on video .....	68
French flags .....	45

Friction on the viewfinder, setting	
maintenance .....	92
variable .....	38
Fuses, changing .....	13

## G

Gears, replacing .....	87
Glass window in the magazine, replacing .....	89
Graduated filter .....	45

## H

Handgrip .....	11
Heated eyecup HE-3 .....	48
HS camera	
flange focal distance .....	98
magazines .....	16, 30, 98
setting speed .....	57
speed range .....	56
Hydro heads, recommended .....	7

## I

Illuminated frame viewfinder .....	67
Illumination	
camera control unit .....	69

camera display .....	55	Lens support LS-7 .....	36
Image adjustment on video monitor .....	78	Lenses, attaching	
Image format .....	98	41 mm bayonet mount .....	35
Image steadiness compensation .....	38	54mm PL-mount .....	34
Image storing, video-assist-system .....	75	Lenses, removing	
Inching knob .....	26	41 mm bayonet mount .....	36
Installation .....	7	54mm PL-mount .....	34
Intensity of time code recording .....	84	Levelling rod for viewfinder EL-3 .....	47
<b>J</b>		Light-weight follow focus device .....	44
Jointed pull-down film transport claw .....	25	Light-weight matte boxes LMB-2, LMB-3 .....	45
<b>K</b>		Light-weight support LWS-2 .....	41
Key functions on the camera control unit .....	70	conversion Normal 16/Super 16 .....	54
Keys RUN, SEL, SET .....	56	Loading the magazine .....	19
<b>L</b>		Lock for eyecup .....	39
LED, camera run .....	56	Locking	
on the remote ON/OFF switch RS-4 .....	74	magazine to camera .....	30
Left-eye viewing .....	38	SEL key .....	56
Lens alignment, adjusting .....	49	SET key .....	56
Lens-Control-System LCS .....	44	Locking handle on magazine cover .....	17
Lens possibilities .....	32	Loop protector .....	16
with automatic diaphragm .....	33	LTC signal .....	82

- M**
- Magazine
    - attaching ..... 30
    - available varieties ..... 16
    - cleaning ..... 18
    - loading ..... 19
    - removing ..... 31
    - unloading ..... 24
  - Magazine cover ..... 17
  - Magazine drive gears, replacing ..... 87
  - Magazine throat assembly, cleaning ..... 87
  - Mains unit NG 12/24 R ..... 14
  - Maintenance ..... 87
  - Manual brightness tuning, video ..... 75
  - Manual image steadiness adjustment ..... 38
  - Matte box
    - matte box MB-17 ..... 45
    - light-weight- LMB-2/LMB-3 ..... 45
    - production- MB-16 ..... 45
  - Measurement area, exposure meter ..... 66
  - Meters/feet, switching
    - on the camera ..... 58
    - on the camera ..... 58
  - Mirror shutter ..... 26
    - checking setting ..... 27, 68
    - setting ..... 26
  - Mode for display, selecting ..... 55
  - Mounting
    - bridge plate ..... 9
    - camera handgrip ..... 11
    - heated eyecup ..... 48
    - levelling rod for finder ..... 47
    - light-weight support ..... 41
    - shoulder set ..... 11
    - Universal follow focus device ..... 43
    - video-assist-system ..... 76
    - video optic ..... 77
    - viewfinder extension ..... 46
- N**
- Noise ..... 98
  - Normal 16/Super 16 conversion ..... 49
  - NTSC-video-assist-system ..... 75
- O**
- On-board battery NC 24/1,2 ..... 14
  - Operating elements ..... 55
  - Operating errors, Display on camera control unit ..... 70
  - Operating time code ..... 83
  - Optical accessories ..... 41

Optics .....	32
Order numbers .....	100

**P**

PAL-video-assist-system .....	75
Phase shifting when synchr. on a video monitor .....	68
Pitch adjustment .....	25
PL-mount .....	34
Polarizing filters .....	66
Position, adjustment on video image .....	78
Power supply	
on the camera .....	13
on the camera control unit .....	69
Product descriptions .....	1
Production matte box MB-16 .....	45
Programmable speeds .....	56
changing during camera run .....	57
Protective cover for lens opening .....	33
Protective cover for video optic .....	78

**Q**

Quietness, optimization through pitch adjustment ....	25
---	----

**R**

Reflex protection ring .....	45
Remote control through the camera control unit ....	69
Remote ON/OFF switches RS-3/RS-4 .....	74
Removing	
compensation adapter .....	36
lens, 41 mm bayonet mount .....	36
lens, 54mm PL-mount .....	34
magazine from camera .....	31
Replacing	
beamsplitter .....	76
electronic housing .....	94
fiber optic screens .....	29
fuses .....	13
glass window in magazine .....	89
lens on TC-recording unit .....	89
magazine drive gear .....	87
Resetting total counter .....	58
RUN key .....	56

**S**

Safety instructions .....	1
SEL key, locking .....	56
SET key, locking .....	56

Setting	
film speed .....	66
focus, video image .....	78
image, video image .....	78
mirror shutter opening .....	26
time code sensitivity .....	84
Shoulder pad .....	11
Shoulder set S-3 .....	11
Shutter adjustment knob, video optic .....	78
Sliding switch, setting speed .....	56
Socket, BAT .....	14
Speed, setting	
on the camera .....	56
on the camera control unit .....	71
Speed, standard .....	56
Spiral battery cable KC 29 .....	14
Step-down gear, Universal follow focus device .....	44
Stop, automatic .....	26
Storage .....	7
Super 16/Normal 16 conversion .....	49
Support ring .....	36
Support rods .....	7
Symbols in the handbook .....	6
Synchronization	
on a video monitor .....	68
on several video cameras .....	75
through the external synchronization unit .....	74
Synchronous running .....	56
<b>T</b>	
Take/total exposed film counter, switching	
on the camera .....	58
on the camera control unit .....	73
TC symbol .....	81
TCS value (time code sensitivity) .....	84
Technical data .....	98
Temperature range .....	99
Threading	
film-, feed-side .....	20
film-, take-up side .....	21
Time code .....	80
buffer .....	86
changing the lens on the recording unit .....	89
checking the recording unit .....	86
display on camera control unit .....	72
generator .....	80
input .....	82
output .....	82
recording unit .....	16
setting sensitivity .....	84
status display .....	80
switching on/off the recording .....	83

time and user bits display .....	84
when using the external synchronization unit ...	83
Transport .....	7
Transport case .....	7
Tripod heads, recommended .....	7

## U

Universal film gate, changing the sector .....	50
Universal follow focus FF-3 .....	43
Unloading the magazine .....	24
User bits, display .....	84
User bits on the camera control unit, setting .....	73

## V

VARIO-SONNAR .....	33
support ring .....	41
Video-Assist-System .....	75
aligning the optic .....	78
conversion Normal 16/Super 16 .....	54
mounting .....	76
mounting the optic .....	77
wiring .....	78
Video camera, color CCD 2-FR .....	75
Video carrying handle .....	75
Video monitor, synchronizing .....	68

Video set .....	75
Viewfinder .....	38
changing alignment .....	52
extension FE-2 .....	46
setting friction .....	92
Viewing height, setting with levelling rods .....	47

## W

Warning instructions .....	1
Warning signs in the viewfinder .....	38
Weight .....	99
White balance, video .....	75

## Z

Zeiss lenses .....	32
--------------------	----

Technical data are subject to change without notice.



# ARRI Service

**Germany** ..... Arnold & Richter Cine Technik  
Türkenstraße 89  
D-80799 München  
phone: (089) 3809-0  
fax: (089) 3809-1244  
fax service: (089) 3809-1793  
E-mail service: [KDenk@arri.de](mailto:KDenk@arri.de)

**USA** ..... ARRI USA  
617, Route 303  
Blauvelt, New York 10913  
phone: (914) 353 14 00  
fax: (914) 425 12 50  
E-mail: [arriflex@arri.com](mailto:arriflex@arri.com)

ARRI USA  
600 North Victory Blvd.  
Burbank, California 91502  
phone: (818) 841 70 70  
fax: (818) 848 40 28  
E-mail: [arriflex@arri.com](mailto:arriflex@arri.com)

**GB** ..... ARRI (GB) Ltd.  
The Movie House  
1-3 Airlinks, Spitfire Way  
phone: (0208) 848 88 81  
fax: (0208) 561 13 12  
E-mail: [sales@arri-gb.com](mailto:sales@arri-gb.com)

**Italy** ..... ARRI ITALIA S.R.L.  
Viale Edison 318  
20099 Sesto S. Giovanni (Milano)  
phone: (02) 26 22 71 75  
fax: (02) 242 16 92  
E-mail: [info@arri.it](mailto:info@arri.it)

ARRI ITALIA S.R.L.  
Via Placanica, 97  
00040 Morena (Roma)  
phone: (06) 79 89 02 02  
fax: (06) 79 89 02 39

**Canada** ..... ARRI Canada Ltd.  
415 Horner Avenue, Unit 11  
Etobicoke, Ontario  
Canada M8W 4W3  
phone: (416) 255 33 35  
fax: (416) 255 33 99  
E-mail: [service@arrican.com](mailto:service@arrican.com)